

Profiles - The DNA of Stone

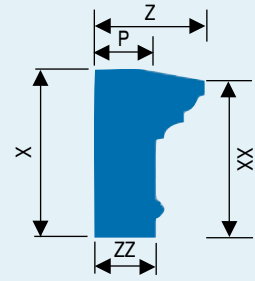
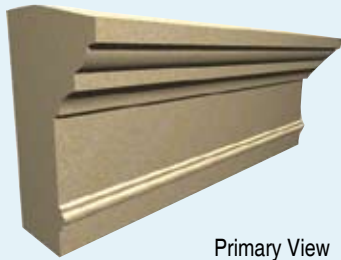

Type Description
Profile

Primary View

View Modifiers

Surname

Addison

	X	Z	Y	XX	ZZ	P	Unit ID	Cost Factor/Lf	Weight/Lf
Addison1	15 1/2"	10"	12"	14 1/2"	5 1/2"	4"	10134	1860	123

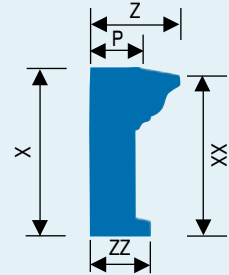
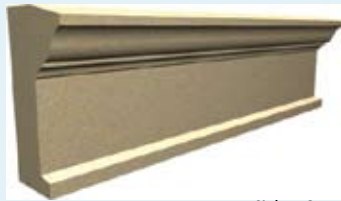

Type Description
Profile

View Modifiers

Surname

Antigua

	X	Z	Y	XX	ZZ	P	Unit ID	Cost Factor/Lf	Weight/Lf
Antigua1	11"	6"	12"	10 1/2"	4"	3"	16297	862	59



Arcadia2 with Niche and Arcadia2A with niche come with an area out of the stone to hold recessed lighting or a gutter or other architectural element.

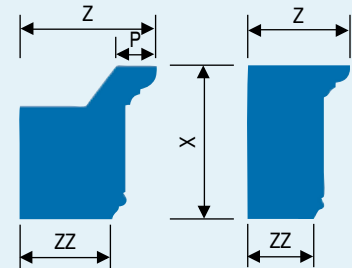

Type Description
Profile

View Modifiers

Surname

Arcadia

	X	Z	Y	XX	ZZ	P	Unit ID	Cost Factor/Lf	Weight/Lf
Arcadia3	7 1/4"	7 3/8"	12"	-	3 3/4"	-	10158	642	43
Arcadia2	11 3/8"	10 1/16"	12"	-	6 3/4"	-	10154	1320	104
Arcadia2 with niche	11 3/8"	10 1/16"	12"	-	6 3/4"	3 1/2"	534	1320	104
Arcadia2A	11 3/8"	8 1/2"	12"	-	5 1/16"	-	10156	1161	79
Arcadia2A with niche	11 3/8"	8 1/2"	12"	-	5 1/16"	3 1/2"	535	1161	79
Arcadia1	13 5/8"	10 1/16"	12"	-	6 3/4"	-	10152	1395	112
Arcadia1A	13 5/8"	6"	12"	-	2 5/8"	-	10153	984	60

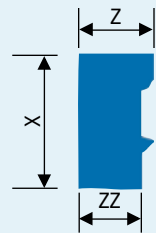
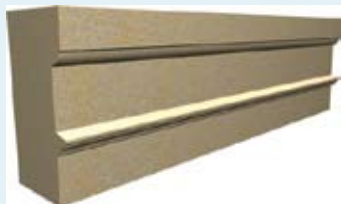

Type Description
Profile

View Modifiers

Surname

Ariel

	X	Z	Y	XX	ZZ	P	Unit ID	Cost Factor/Lf	Weight/Lf
Ariel3	7 1/4"	6"	12"	-	5"	-	10165	556	36
Ariel5	9"	8"	12"	-	7"	-	16308	873	76

Profiles - The DNA of Stone

Type Description
Profile

Primary View

View Modifiers

Surname

Ariel. continued

Ariel4	10 ³ / ₈ "	5 ¹ / ₈ "	12"	-	4 ¹ / ₈ "	-	10169	693	49
Ariel1	10 ⁷ / ₈ "	6"	12"	-	5"	-	10165	783	55
Ariel1A	10 ⁷ / ₈ "	4 ¹ / ₂ "	12"	-	3 ¹ / ₂ "	-	10166	622	41
Ariel2	10 ⁷ / ₈ "	9"	12"	-	8"	-	10167	1175	83

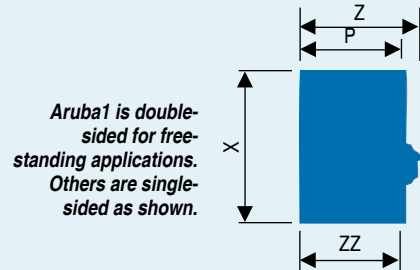
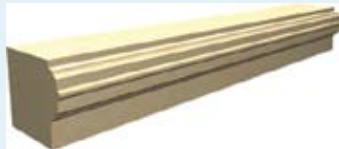

Type Description
Profile

View Modifiers

Surname

Aruba

	X	Z	Y	XX	ZZ	P	Unit ID	Cost Factor/Lf	Weight/Lf
Aruba3	5"	5 ¹ / ₈ "	12"	-	4 ¹ / ₈ "	4 ¹ / ₈ "	10178	395	25
Aruba2	12 ⁷ / ₈ "	22 ¹ / ₁₆ "	12"	-	22 ¹ / ₁₆ "	22 ¹ / ₁₆ "	10176	3089	265
Aruba2A	12 ⁷ / ₈ "	5 ¹ / ₄ "	12"	-	4"	4"	10177	811	53
Aruba1	15 ⁵ / ₈ "	13 ³ / ₈ "	12"	-	11"	11"	10174	2186	169
Aruba1A	15 ⁵ / ₈ "	10 ¹ / ₂ "	12"	-	9 ⁵ / ₁₆ "	9 ⁵ / ₁₆ "	10175	1741	141

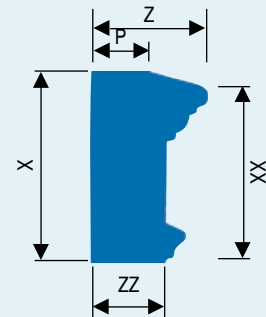

Type Description
Profile

View Modifiers

Surname

Astor

	X	Z	Y	XX	ZZ	P	Unit ID	Cost Factor/Lf	Weight/Lf
Astor3	8 ¹ / ₄ "	7"	12"	7 ¹ / ₂ "	4 ¹ / ₂ "	3 ³ / ₄ "	10182	743	46
Astor2	11 ¹ / ₄ "	7"	12"	10 ³ / ₄ "	4 ¹ / ₂ "	3 ³ / ₄ "	10181	972	66
Astor1	14 ¹ / ₂ "	8"	12"	14 ¹ / ₈ "	5 ¹ / ₄ "	4 ³ / ₄ "	10179	1216	89

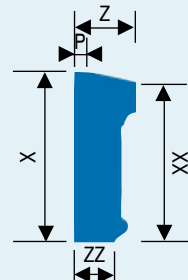

Type Description
Profile

View Modifiers

Surname

Aveiro

	X	Z	Y	XX	ZZ	P	Unit ID	Cost Factor/Lf	Weight/Lf
Aveiro1	9"	3 ³ / ₈ "	12"	8 ¹ / ₂ "	2 ¹ / ₁₆ "	1"	15365	430	26

Profiles - The DNA of Stone

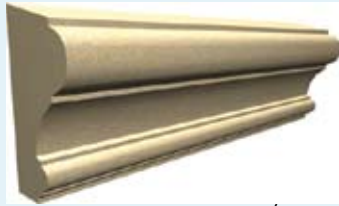

Type Description
Profile

View Modifiers

Surname

Aztec

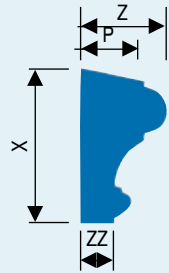

	X	Z	Y	XX	ZZ	P	Unit ID	Cost Factor/Lf	Weight/Lf
Aztec2	11 ¹ / ₁₆ "	3 ¹¹ / ₁₆ "	12"	-	2"	-	10184	792	38
Aztec1	12"	6 ³ / ₄ "	12"	-	2 ³ / ₄ "	5"	10183	972	62
Aztec3	14"	7 ¹ / ₄ "	12"	-	3"	5 ¹ / ₄ "	16306	1116	77

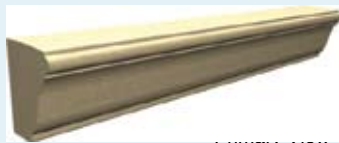

Type Description
Profile

View Modifiers

Surname

Baird

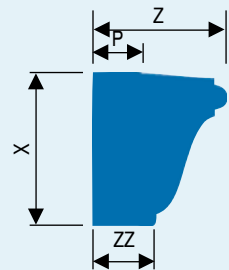

	X	Z	Y	XX	ZZ	P	Unit ID	Cost Factor/Lf	Weight/Lf
Baird1	6"	5 ¹ / ₄ "	12"	-	1 ¹ / ₄ "	1 ¹ / ₂ "	10187	435	22



Type Description
Profile

View Modifiers

Surname

Basil

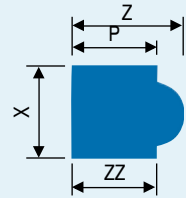

	X	Z	Y	XX	ZZ	P	Unit ID	Cost Factor/Lf	Weight/Lf
Basil1	4"	5 ¹ / ₈ "	12"	-	3 ⁷ / ₈ "	3 ⁷ / ₈ "	10205	363	18
Basil3	4"	4 ⁵ / ₈ "	12"	-	3 ⁵ / ₈ "	3 ⁵ / ₈ "	10207	355	17
Basil5	4 ¹ / ₄ "	5"	12"	-	4"	4"	10208	366	20
Basil2	5 ¹ / ₄ "	6 ⁵ / ₈ "	12"	-	5"	5"	10206	420	31
Basil6	5 ¹ / ₄ "	6 ⁷ / ₈ "	12"	-	5 ⁵ / ₈ "	5 ⁵ / ₈ "	15181	504	34



Type Description
Profile

View Modifiers

Surname

Bastion

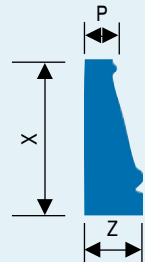

	X	Z	Y	XX	ZZ	P	Unit ID	Cost Factor/Lf	Weight/Lf
Bastion1	12"	4 ⁵ / ₈ "	12"	-	4 ⁵ / ₈ "	2 ¹ / ₄ "	14718	673	44
Bastion3	12"	5 ⁵ / ₈ "	12"	-	5 ⁵ / ₈ "	3 ⁵ / ₈ "	14514	726	54
Bastion2	18"	6 ¹⁵ / ₁₆ "	12"	-	6 ¹⁵ / ₁₆ "	3 ³ / ₈ "	16309	1117	77

Profiles - The DNA of Stone

Type Description
Profile

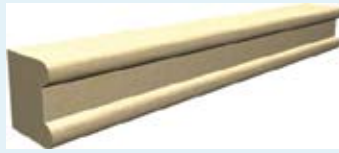

View Modifiers

Surname

Beasley

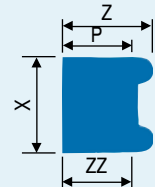

	X	Z	Y	XX	ZZ	P	Unit ID	Cost Factor/Lf	Weight/Lf
Beasley1	4 ³ / ₄ "	4 ³ / ₄ "	12"	-	4"	4"	10220	400	20
Beasley2	6"	4 ³ / ₄ "	12"	-	4"	4"	10221	438	25
Beasley4	9"	5 ¹ / ₄ "	12"	-	4 ¹ / ₂ "	4 ¹ / ₂ "	16310	567	43
Beasley3	10"	7 ¹ / ₄ "	12"	-	6 ³ / ₁₆ "	6 ³ / ₁₆ "	14580	864	66

Type Description
Profile

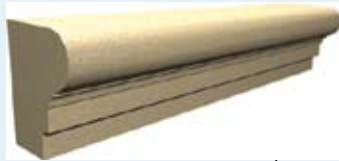

View Modifiers

Surname

Beckman

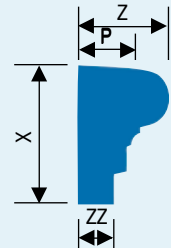

	X	Z	Y	XX	ZZ	P	Unit ID	Cost Factor/Lf	Weight/Lf
Beckman1	8"	6 ⁷ / ₈ "	12"	-	3 ⁵ / ₈ "	5 ³ / ₁₆ "	10224	660	40
Beckman1A	8"	5 ¹ / ₂ "	12"	-	2 ¹ / ₄ "	4 ¹ / ₈ "	10226	528	30
Beckman2	8"	8 ⁷ / ₁₆ "	12"	-	4 ¹ / ₂ "	7"	10227	816	52
Beckman3	6"	7 ¹ / ₂ "	12"	-	4 ¹ / ₂ "	6 ¹ / ₂ "	10228	540	37
Beckman4	7 ⁵ / ₈ "	6 ⁷ / ₈ "	12"	-	3 ⁵ / ₈ "	5 ³ / ₁₆ "	10229	632	37
Beckman6	9"	6"	12"	-	3"	4 ¹ / ₂ "	16171	675	43
Beckman5	14"	8 ⁵ / ₁₆ "	12"	-	4 ⁵ / ₁₆ "	7"	10230	1344	89

Type Description
Profile



View Modifiers

Surname

Belmont

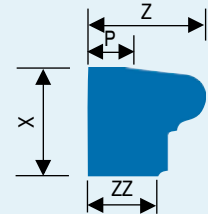

	X	Z	Y	XX	ZZ	P	Unit ID	Cost Factor/Lf	Weight/Lf
Belmont1	6"	5"	12"	-	2 ¹ / ₄ "	4"	14381	401	27
Belmont2	6"	7"	12"	-	4 ¹ / ₄ "	2"	15358	462	31

Type Description
Profile

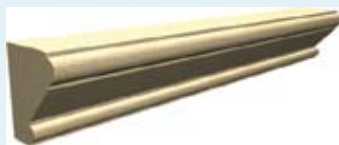

View Modifiers

Surname

Belton

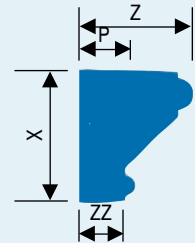

	X	Z	Y	XX	ZZ	P	Unit ID	Cost Factor/Lf	Weight/Lf
Belton3	5 ¹ / ₂ "	5 ³ / ₈ "	12"	-	2 ¹ / ₄ "	3 ⁵ / ₈ "	12941	362	28
Belton1	6"	5 ³ / ₈ "	12"	-	2 ¹ / ₄ "	3 ⁵ / ₈ "	10232	395	29
Belton1A	6"	4 ¹ / ₄ "	12"	-	1 ¹ / ₈ "	2 ¹ / ₂ "	10234	380	21
Belton2	6"	7 ³ / ₁₆ "	12"	-	3 ⁵ / ₈ "	5 ³ / ₁₆ "	10235	630	38

301 Pleasant Drive • Dallas, TX 75217
 (800) 398-1199 • FAX (214) 398-1293
 www.stonelegends.com • sales@stonelegends.com

STONE LEGENDS

Profiles - The DNA of Stone



Type Description
Profile

View Modifiers

Surname
Belvue

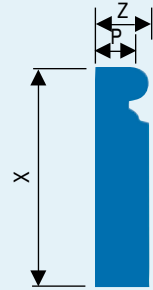

	X	Z	Y	XX	ZZ	P	Unit ID	Cost Factor/Lf	Weight/Lf
Belvue2	6 ³ / ₄ "	4 ³ / ₄ "	12"	-	4 ³ / ₄ "	3 ⁷ / ₈ "	15249	389	29
Belvue1	12"	3"	12"	-	3"	2 ¹ / ₁₆ "	15248	432	33
Belvue1A	12"	5 ³ / ₄ "	12"	-	5 ³ / ₄ "	4 ⁷ / ₈ "	16380	828	65



Type Description
Profile

View Modifiers

Surname
Bolson

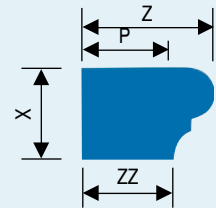

	X	Z	Y	XX	ZZ	P	Unit ID	Cost Factor/Lf	Weight/Lf
Bolson13	2 ¹ / ₂ "	13 ¹ / ₂ "	12"	-	12"	12"	10288	350	19
Bolson5	2 ¹ / ₂ "	5 ¹ / ₈ "	12"	-	3 ⁷ / ₈ "	3 ⁷ / ₈ "	10306	350	11
Bolson19	2 ³ / ₄ "	15 ³ / ₈ "	12"	2 ⁵ / ₁₆ "	14"	14"	14745	509	38
Bolson16	3 ¹ / ₄ "	8"	12"	3"	5 ³ / ₄ "	6"	16506	352	22
Bolson4	3 ¹ / ₂ "	8 ³ / ₈ "	12"	-	6 ⁷ / ₈ "	6 ⁷ / ₈ "	10304	395	25
Bolson20	3 ¹ / ₂ "	6 ³ / ₄ "	12"	-	4 ³ / ₄ "	4 ³ / ₄ "	10301	284	23
Bolson6	3 ⁵ / ₈ "	8 ¹ / ₂ "	12"	3 ¹ / ₈ "	7"	7"	10307	396	28
Bolson6A	3 ⁵ / ₈ "	6 ³ / ₄ "	12"	3 ¹ / ₈ "	5 ¹ / ₄ "	5 ¹ / ₄ "	10309	354	23
Bolson10	3 ³ / ₄ "	19 ¹ / ₈ "	12"	-	17"	17"	10285	863	66
Bolson7	4"	7"	12"	3 ⁵ / ₈ "	5"	5"	14944	353	24
Bolson11	4"	5 ³ / ₄ "	12"	-	4"	4 ⁵ / ₈ "	10286	355	21
Bolson17	4 ¹ / ₂ "	13 ¹ / ₂ "	12"	-	11"	11"	10293	624	49
Bolson17A	4 ¹ / ₂ "	7 ¹ / ₁₆ "	12"	-	2 ⁵ / ₈ "	5"	16507	378	27
Bolson12	4 ⁷ / ₈ "	18"	12"	-	15 ⁷ / ₁₆ "	16 ⁵ / ₈ "	15998	1054	79
Bolson1	5"	7"	12"	-	4 ¹ / ₂ "	5 ¹ / ₂ "	10282	420	31
Bolson1A	5"	6 ¹ / ₈ "	12"	-	3 ⁵ / ₈ "	4 ⁵ / ₈ "	10296	393	27
Bolson2	5"	5 ³ / ₄ "	12"	4 ⁵ / ₈ "	3 ¹ / ₂ "	4 ⁵ / ₈ "	10298	375	26
Bolson2A	5"	8"	12"	-	5 ³ / ₄ "	6 ¹ / ₂ "	10302	480	32
Bolson9	5"	6"	12"	4 ¹ / ₂ "	2 ⁵ / ₈ "	4 ³ / ₄ "	9394	380	24
Bolson3	5 ¹ / ₂ "	7 ⁵ / ₈ "	12"	5"	5 ¹ / ₄ "	5 ¹ / ₄ "	10303	506	38
Bolson8	5 ³ / ₈ "	5 ⁷ / ₈ "	12"	-	2 ¹ / ₄ "	3 ³ / ₄ "	10311	382	28
Bolson21	6"	7 ⁵ / ₈ "	12"	5 ⁵ / ₈ "	5 ¹ / ₄ "	5 ¹ / ₄ "	10300	540	41
Bolson15	7 ¹ / ₁₆ "	17 ¹ / ₂ "	12"	2 ¹ / ₂ "	15"	-	10291	1345	100
Bolson14	8"	8 ¹ / ₄ "	12"	7 ³ / ₄ "	4"	3 ¹ / ₂ "	10289	792	47
Bolson14A	8"	9 ¹ / ₄ "	12"	7 ³ / ₄ "	5"	4 ¹ / ₂ "	10290	938	56
Bolson18	9"	5 ¹ / ₄ "	12"	8 ¹ / ₂ "	2 ⁵ / ₈ "	-	10294	624	43

Profiles - The DNA of Stone

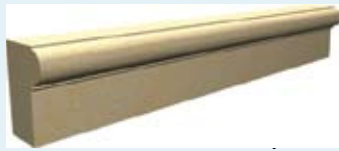

Type Description
Profile

View Modifiers

Surname
Blaise

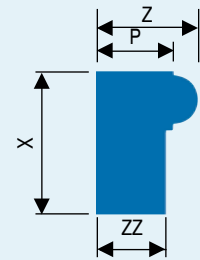

	X	Z	Y	XX	ZZ	P	Unit ID	Cost Factor/Lf	Weight/Lf
Blaise1	5 ⁷ / ₈ "	12 ³ / ₄ "	12"	-	11 ¹ / ₆ "	11 ¹ / ₆ "	10254	899	64
Blaise1A	5 ⁷ / ₈ "	4 ¹ / ₄ "	12"	-	3"	3"	10255	405	20



Type Description
Profile

View Modifiers

Surname
Bolt

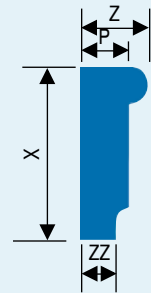

	X	Z	Y	XX	ZZ	P	Unit ID	Cost Factor/Lf	Weight/Lf
Bolt1	6 ³ / ₄ "	2 ³ / ₄ "	12"	-	1 ¹ / ₂ "	2"	15357	223	12



Type Description
Profile

View Modifiers

Surname
Bowen

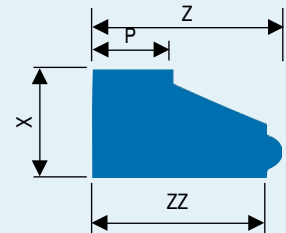

	X	Z	Y	XX	ZZ	P	Unit ID	Cost Factor/Lf	Weight/Lf
Bowen2	5 ¹ / ₄ "	7 ⁵ / ₈ "	12"	-	6 ³ / ₄ "	3 ⁵ / ₈ "	16313	457	36
Bowen1	5 ¹ / ₄ "	8 ³ / ₈ "	12"	-	7 ⁵ / ₈ "	3 ⁵ / ₈ "	10343	528	41



Type Description
Profile

View Modifiers

Surname
Bratten

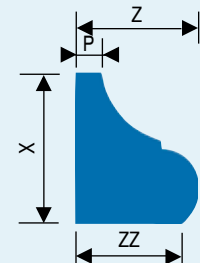

	X	Z	Y	XX	ZZ	P	Unit ID	Cost Factor/Lf	Weight/Lf
Bratten1	8 ³ / ₄ "	7 ¹ / ₄ "	12"	-	6 ¹ / ₈ "	1 ¹ / ₈ "	16132	762	57
Bratten1A	8 ³ / ₄ "	11 ¹ / ₆ "	12"	-	10 ³ / ₈ "	5 ³ / ₄ "	16133	932	70

301 Pleasant Drive • Dallas, TX 75217
 (800) 398-1199 • FAX (214) 398-1293
 www.stonelegends.com • sales@stonelegends.com

STONE LEGENDS

Profiles - The DNA of Stone

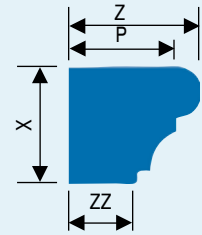
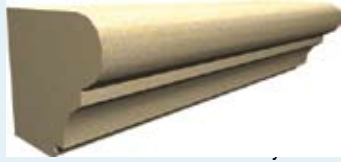

Type Description
Profile

View Modifiers

Surname

Brookside

	X	Z	Y	XX	ZZ	P	Unit ID	Cost Factor/Lf	Weight/Lf
Brookside3	6"	10 1/2"	12"	-	5 1/2"	8 1/2"	10360	756	54
Brookside4	8"	10"	12"	-	4"	8"	15431	960	73
Brookside1	9"	10 1/2"	12"	-	5 1/2"	8 1/2"	9398	918	69
Brookside1A	9"	6 1/2"	12"	-	1 1/2"	4 1/2"	10358	693	44
Brookside2	9"	11 1/2"	12"	-	7 1/2"	9 1/2"	10359	912	69

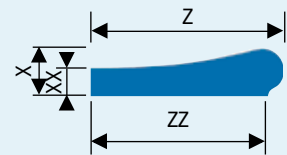

Type Description
Profile

View Modifiers

Surname

Bullfrog

	X	Z	Y	XX	ZZ	P	Unit ID	Cost Factor/Lf	Weight/Lf
Bullfrog1	3 1/8"	13 5/8"	12"	2 5/8"	12 1/4"	-	10369	512	35
Bullfrog2	4"	13 1/4"	12"	2 3/4"	12"	-	16383	636	46
Bullfrog3	4"	15 1/2"	12"	2 1/2"	14 1/4"	-	14730	744	53

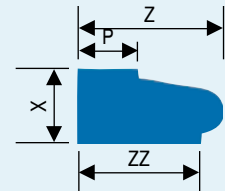

Type Description
Profile

View Modifiers

Surname

Bullet

	X	Z	Y	XX	ZZ	P	Unit ID	Cost Factor/Lf	Weight/Lf
Bullet3	4"	5 1/2"	12"	-	4"	1 15/16"	10364	410	21
Bullet3A	4"	8 15/16"	12"	-	7 9/16"	5 1/2"	16318	447	29
Bullet6	4 1/4"	6 3/4"	12"	-	5 1/4"	1"	10367	420	24
Bullet2	4 7/8"	6 1/2"	12"	-	5"	1/2"	10363	427	23
Bullet1	5"	9 1/2"	12"	-	8"	4"	10362	570	36
Bullet5	5 1/2"	7 1/2"	12"	-	6 1/2"	4 1/2"	10366	510	32
Bullet4	5 3/4"	7 5/8"	12"	-	5 5/8"	2 5/8"	10365	516	34

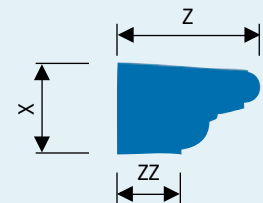

Type Description
Profile

View Modifiers

Surname

Burke

	X	Z	Y	XX	ZZ	P	Unit ID	Cost Factor/Lf	Weight/Lf
Burke1	5 3/8"	8 3/4"	12"	-	4"	-	10465	564	35

Profiles - The DNA of Stone

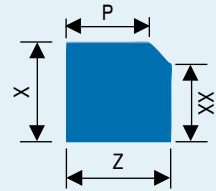

Type Description
Profile

View Modifiers

Surname

Chamber

	X	Z	Y	XX	ZZ	P	Unit ID	Cost Factor/Lf	Weight/Lf
Chamber4	3 ⁵ / ₈ "	7 ⁵ / ₈ "	12"	2 ⁵ / ₈ "	-	6 ⁵ / ₈ "	10680	355	25
Chamber1	4"	9"	12"	2 ¹ / ₂ "	-	7 ¹ / ₂ "	10676	439	32
Chamber9	4"	11 ¹ / ₂ "	12"	3"	-	11"	10686	551	40
Chamber2	4 ⁵ / ₈ "	5"	12"	3 ⁵ / ₈ "	-	4"	10678	365	21
Chamber3	4 ³ / ₄ "	7"	12"	4"	-	5"	10679	412	30
Chamber6	5"	4 ³ / ₄ "	12"	4"	-	3 ³ / ₄ "	10682	373	21
Chamber7	5"	5"	12"	4"	-	4"	10683	390	22
Chamber8	7"	4"	12"	3"	-	3"	10685	405	25
Chamber5	8"	4"	12"	7"	-	3"	10681	421	29

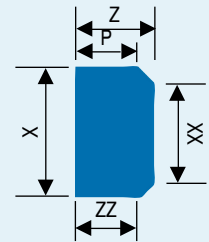

Type Description
Profile

View Modifiers

Surname

Chamfer

	X	Z	Y	XX	ZZ	P	Unit ID	Cost Factor/Lf	Weight/Lf
Chamfer5	4"	4"	12"	2"	3"	3"	10759	388	14
Chamfer4	6"	5"	12"	4"	4"	4"	10754	435	27
Chamfer4A	6"	4"	12"	4"	3"	3"	10755	420	21
Chamfer8	7 ³ / ₈ "	4 ³ / ₈ "	12"	5 ³ / ₈ "	3 ³ / ₈ "	3 ³ / ₈ "	10763	455	32
Chamfer3	8"	5"	12"	6"	4"	4"	10750	480	36
Chamfer3A	8"	4"	12"	6"	3"	3"	10752	465	28
Chamfer7	8"	3"	12"	6"	2"	2"	10761	430	21
Chamfer6	9"	4"	12"	7"	3"	3"	10760	480	32
Chamfer2	10"	5"	12"	8"	4"	4"	9088	600	45
Chamfer2A	10"	4 ¹ / ₄ "	12"	8"	3 ¹ / ₄ "	3 ¹ / ₄ "	9089	510	38
Chamfer1	12"	5"	12"	10"	4"	4"	10744	720	54
Chamfer1A	12"	4"	12"	10"	3"	3"	10748	578	39
Chamfer9	12"	7 ⁵ / ₈ "	12"	10"	6 ⁵ / ₈ "	6 ⁵ / ₈ "	10764	1008	71

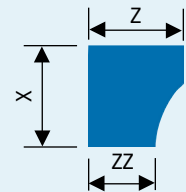

Type Description
Profile

View Modifiers

Surname

Collier

	X	Z	Y	XX	ZZ	P	Unit ID	Cost Factor/Lf	Weight/Lf
Collier1	6"	5 ¹ / ₂ "	12"	-	4"	-	10814	360	26
Collier2	6 ¹ / ₂ "	7 ³ / ₄ "	12"	-	5 ³ / ₄ "	-	10820	605	43
Collier3	8"	5 ¹ / ₂ "	12"	-	4"	-	10821	480	36

Profiles - The DNA of Stone



Type Description
Profile

View Modifiers

Surname
Cordoba

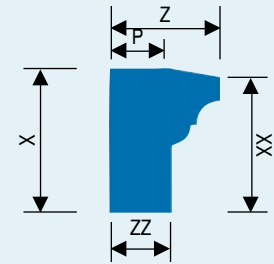

	X	Z	Y	XX	ZZ	P	Unit ID	Cost Factor/Lf	Weight/Lf
Cordoba3	9"	7 ¹ / ₆ "	12"	8 ³ / ₄ "	4"	4"	10854	685	45
Cordoba4	8"	9"	12"	7 ³ / ₄ "	5 ¹ / ₄ "	3 ³ / ₄ "	14574	816	59
Cordoba1	11 ¹ / ₄ "	9"	12"	11"	5 ¹ / ₄ "	3 ³ / ₄ "	10851	1080	69
Cordoba1A	11 ¹ / ₄ "	10 ¹ / ₆ "	12"	11"	6 ³ / ₄ "	5 ¹ / ₄ "	16314	1320	91
Cordoba2	12 ³ / ₄ "	9 ³ / ₄ "	12"	12 ¹ / ₆ "	2 ¹ / ₆ "	3 ¹ / ₆ "	10853	1118	63

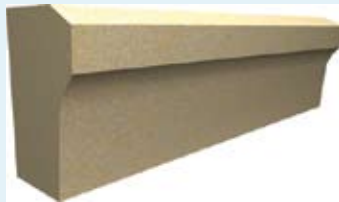

Type Description
Profile

View Modifiers

Surname
Cork

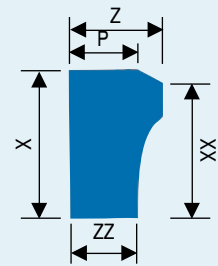

	X	Z	Y	XX	ZZ	P	Unit ID	Cost Factor/Lf	Weight/Lf
Cork5	2 ¹ / ₂ "	11 ¹ / ₂ "	12"	-	11"	11"	14681	338	26
Cork3	7"	7 ¹³ / ₁₆ "	12"	6"	5 ⁷ / ₈ "	5 ⁷ / ₈ "	10862	651	45
Cork4	9"	6 ⁷ / ₈ "	12"	8"	4 ⁷ / ₈ "	4 ⁷ / ₈ "	10863	742	49
Cork1	11"	7 ³ / ₈ "	12"	10"	5 ³ / ₈ "	5 ³ / ₈ "	10860	974	65
Cork2	11 ⁵ / ₈ "	6"	12"	10 ⁵ / ₈ "	4"	4"	10861	840	55
Cork6	12"	6"	12"	11"	4"	4"	16288	864	61



Type Description
Profile

View Modifiers

Surname
Curt

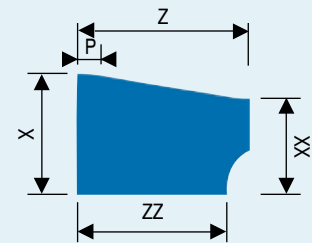

	X	Z	Y	XX	ZZ	P	Unit ID	Cost Factor/Lf	Weight/Lf
Curt1	5"	7 ¹ / ₂ "	12"	4"	6 ¹ / ₂ "	3 ³ / ₄ "	10922	525	30
Curt2	5"	9"	12"	4"	8 ¹ / ₄ "	3 ³ / ₄ "	14573	540	33
Curt3	5"	7"	12"	4"	6"	2 ⁷ / ₁₆ "	16315	429	31

Profiles - The DNA of Stone

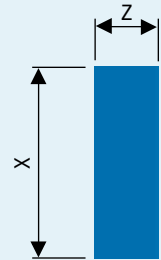

Type Description
Profile

View Modifiers

Surname

Flatface

	X	Z	Y	XX	ZZ	P	Unit ID	Cost Factor/Lf	Weight/Lf
Flatface4	4"	4"	12"	-	-	-	9108	358	14
Flatface3	6"	5"	12"	-	-	-	14557	405	27
Flatface3A	6"	3"	12"	-	-	-	14558	370	16
Flatface3B	6"	4"	12"	-	-	-	9560	387	22
Flatface2	8"	6"	12"	-	-	-	14555	576	43
Flatface2A	8"	4"	12"	-	-	-	14556	461	29
Flatface1	10"	6"	12"	-	-	-	9102	720	54
Flatface1A	10"	4"	12"	-	-	-	14554	480	36

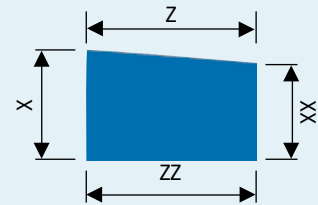

Type Description
Profile

View Modifiers

Surname

FlatfaceSlope

	X	Z	Y	XX	ZZ	P	Unit ID	Cost Factor/Lf	Weight/Lf
FlatfaceSlope8	2 1/2"	5"	12"	2"	-	-	9423	350	12
FlatfaceSlope7	3"	5"	12"	2 1/2"	-	-	9422	360	13
FlatfaceSlope1	3 1/2"	6"	12"	3"	-	-	9416	370	19
FlatfaceSlope9	4"	9 1/4"	12"	3"	-	-	9557	500	32
FlatfaceSlope10	4"	3"	12"	3 3/4"	-	-	14860	350	11
FlatfaceSlope6	4 5/8"	8"	12"	4 1/8"	-	-	13358	450	31
FlatfaceSlope3	4 5/8"	9"	12"	4 1/8"	-	-	9418	483	34
FlatfaceSlope5	5 1/4"	9 1/4"	12"	4 3/4"	-	-	9420	600	42
FlatfaceSlope4	6 1/4"	11 1/2"	12"	5 1/2"	-	-	9419	850	61
FlatfaceSlope2	7 1/2"	6"	12"	6 1/2"	-	-	9417	540	39



Type Description
Profile

Galaxy1 Front

Primary View

View Modifiers

Surname

Galaxy

	X	Z	Y	XX	ZZ	P	Unit ID	Cost Factor/Lf	Weight/Lf
Galaxy1	8"	5 3/4"	20"	-	-	-	15344	3200	63

Available only in 20" pieces.

301 Pleasant Drive • Dallas, TX 75217
 (800) 398-1199 • FAX (214) 398-1293
 www.stonelegends.com • sales@stonelegends.com

STONE LEGENDS

Profiles - The DNA of Stone

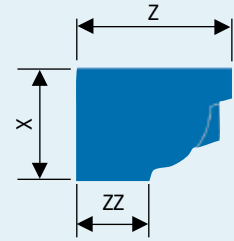

Type Description
Profile

Primary View

View Modifiers

Surname
Gambit

	X	Z	Y	XX	ZZ	P	Unit ID	Cost Factor/Lf	Weight/Lf
Gambit1	7 1/2"	10 1/2"	12"	-	5"	-	14680	1890	69

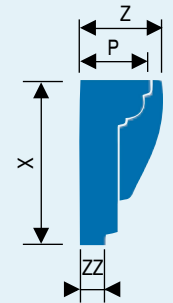

Type Description
Profile

Primary View

View Modifiers

Surname
Geneva

	X	Z	Y	XX	ZZ	P	Unit ID	Cost Factor/Lf	Weight/Lf
Geneva1	11"	5 1/2"	12"	-	1 7/8"	-	11547	1150	35
Geneva1A	11"	7 1/2"	12"	-	3 7/8"	-	15080	1848	56

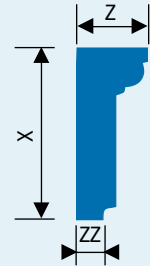

Type Description
Profile

View Modifiers

Surname
Genova

	X	Z	Y	XX	ZZ	P	Unit ID	Cost Factor/Lf	Weight/Lf
Genova1	11"	6 3/4"	12"	-	3 7/8"	-	15081	792	49

Genova is Geneva without the dentil blocks.

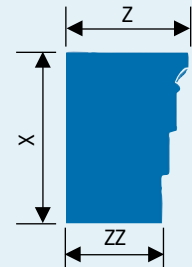

Type Description
Profile

Primary View

View Modifiers

Surname
Genevieve

	X	Z	Y	XX	ZZ	P	Unit ID	Cost Factor/Lf	Weight/Lf
Genevieve1	10 3/4"	7 3/4"	12"	-	6"	-	15338	1999	69

Genevieve1 is available only in 35 5/8" pieces.

Profiles - The DNA of Stone

Type Description	Primary View	View Modifiers	Surname						
Profile	X	Z	Y	XX	ZZ	P	Unit ID	Cost Factor/Lf	Weight/Lf
Gentian1	3 1/4"	7 1/4"	12"	-	5 1/2"	-	15342	906	19

Gentian1 is available only in 35 5/8" pieces.

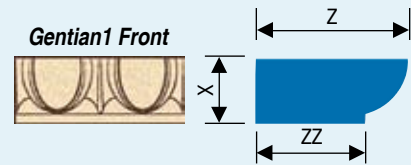

Type Description	Primary View	View Modifiers	Surname						
Profile	X	Z	Y	XX	ZZ	P	Unit ID	Cost Factor/Lf	Weight/Lf
GentryDentil	2"	4 5/8"	12"	-	2 5/8"	2 5/8"	9629	1084	7
GentryOgee1	5 7/16"	6"	12"	-	5"	3"	11551	591	20
Gentry1OgeeCombined	5 7/16"	8"	12"	-	5"	5 5/8"	14515	1675	27

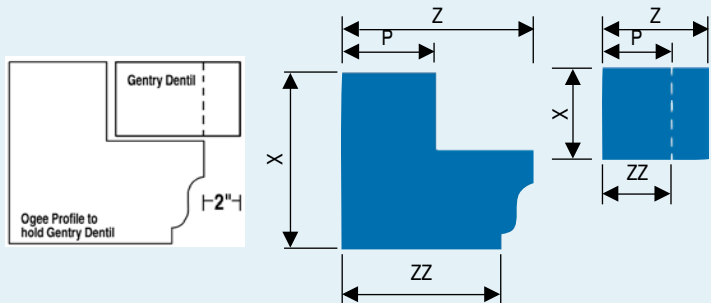

Type Description	Primary View	View Modifiers	Surname						
Profile	X	Z	Y	XX	ZZ	P	Unit ID	Cost Factor/Lf	Weight/Lf
Georgian10	3 5/8"	4 5/8"	12"	-	4 5/8"	-	11553	355	16
Georgian13	4 1/2"	1 1/2"	12"	-	1"	-	11556	352	7
Georgian11	4 5/8"	4"	12"	-	3 3/4"	-	11554	370	18
Georgian2	5"	4"	12"	-	3 11/16"	-	11561	385	18
Georgian2A	5"	3"	12"	-	2 11/16"	-	11562	355	13
Georgian3	5 1/4"	4"	12"	-	3 1/2"	-	11563	398	18
Georgian9	5 3/8"	4"	12"	-	3 1/4"	-	11569	403	22
Georgian6	6"	3"	12"	-	2 5/8"	-	11566	373	16
Georgian7	6"	3"	12"	-	2 1/2"	-	11567	373	16
Georgian16	6 3/4"	3"	12"	-	2 3/4"	-	11559	383	18
Georgian17	7"	3"	12"	-	2 3/4"	-	14652	398	19
Georgian1	8"	4"	12"	-	3 1/2"	-	11552	434	28
Georgian1A	8"	6 1/2"	12"	-	6"	-	11560	624	42
Georgian12A	8"	6"	12"	-	5 5/16"	-	14593	576	39
Georgian5	11"	5"	12"	-	4"	-	11565	660	49
Georgian12	12"	6"	12"	-	5 1/2"	-	11555	864	65
Georgian14	12"	4"	12"	-	3 1/2"	-	11557	576	44
Georgian4	12 3/4"	4"	12"	-	3 1/2"	-	11564	612	45
Georgian15	13 1/8"	3"	12"	-	2 3/4"	-	11558	473	35
Georgian8	16"	4"	12"	-	2 5/8"	-	11568	768	58



Type Description	View Modifiers	Surname							
Profile	X	Z	Y	XX	ZZ	P	Unit ID	Cost Factor/Lf	Weight/Lf
Georgian10	3 5/8"	4 5/8"	12"	-	4 5/8"	-	11553	355	16
Georgian13	4 1/2"	1 1/2"	12"	-	1"	-	11556	352	7
Georgian11	4 5/8"	4"	12"	-	3 3/4"	-	11554	370	18
Georgian2	5"	4"	12"	-	3 11/16"	-	11561	385	18
Georgian2A	5"	3"	12"	-	2 11/16"	-	11562	355	13
Georgian3	5 1/4"	4"	12"	-	3 1/2"	-	11563	398	18
Georgian9	5 3/8"	4"	12"	-	3 1/4"	-	11569	403	22
Georgian6	6"	3"	12"	-	2 5/8"	-	11566	373	16
Georgian7	6"	3"	12"	-	2 1/2"	-	11567	373	16
Georgian16	6 3/4"	3"	12"	-	2 3/4"	-	11559	383	18
Georgian17	7"	3"	12"	-	2 3/4"	-	14652	398	19
Georgian1	8"	4"	12"	-	3 1/2"	-	11552	434	28
Georgian1A	8"	6 1/2"	12"	-	6"	-	11560	624	42
Georgian12A	8"	6"	12"	-	5 5/16"	-	14593	576	39
Georgian5	11"	5"	12"	-	4"	-	11565	660	49
Georgian12	12"	6"	12"	-	5 1/2"	-	11555	864	65
Georgian14	12"	4"	12"	-	3 1/2"	-	11557	576	44
Georgian4	12 3/4"	4"	12"	-	3 1/2"	-	11564	612	45
Georgian15	13 1/8"	3"	12"	-	2 3/4"	-	11558	473	35
Georgian8	16"	4"	12"	-	2 5/8"	-	11568	768	58

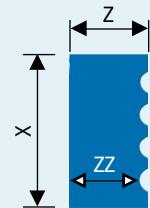

301 Pleasant Drive • Dallas, TX 75217
 (800) 398-1199 • FAX (214) 398-1293
 www.stonelegends.com • sales@stonelegends.com

STONE LEGENDS

Profiles - The DNA of Stone

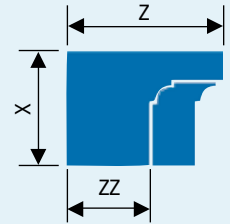

Type Description
Profile

Primary View

View Modifiers

Surname

Glencoe

	X	Z	Y	XX	ZZ	P	Unit ID	Cost Factor/Lf	Weight/Lf
Glencoe2	5 1/2"	10 1/2"	12"	-	7"	-	15327	1526	44
Glencoe1	5 5/8"	11"	12"	-	7 1/2"	-	9631	1795	51
Glencoe1A	5 5/8"	8"	12"	-	5"	-	16322	1257	36

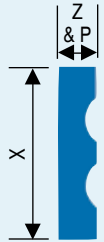

Type Description
Profile

View Modifiers

Surname

Gordon

	X	Z	Y	XX	ZZ	P	Unit ID	Cost Factor/Lf	Weight/Lf
Gordon2	11 5/8"	3 5/8"	12"	-	-	3 5/8"	15074	515	37
Gordon1	16"	3 5/8"	12"	-	-	3 5/8"	11575	705	51



Gregorian1 Front

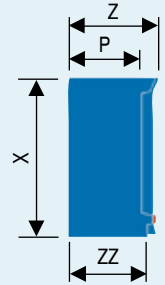

Type Description
Profile

Primary View

View Modifiers

Surname

Gregorian

	X	Z	Y	XX	ZZ	P	Unit ID	Cost Factor/Lf	Weight/Lf
Gregorian1	7 3/8"	4"	33 3/8"	-	3 1/2"	3 1/4"	16128	2625	74

Gregorian1 is available only in 33 3/8" lengths.

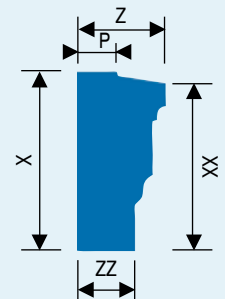

Type Description
Profile

View Modifiers

Surname

Jacob

	X	Z	Y	XX	ZZ	P	Unit ID	Cost Factor/Lf	Weight/Lf
Jacob1	10"	5"	12"	9 5/16"	3 1/4"	2 1/4"	15976	636	32

Profiles - The DNA of Stone

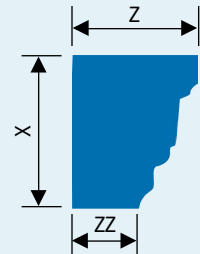

Type Description
Profile

View Modifiers

Surname

Jamison

	X	Z	Y	XX	ZZ	P	Unit ID	Cost Factor/Lf	Weight/Lf
Jamison12	4 ¹³ / ₁₆ "	3 ³ / ₄ "	12"	-	1 ¹ / ₄ "	-	16325	377	15
Jamison2	5 ¹ / ₄ "	5 ¹ / ₂ "	12"	-	3 ¹ / ₈ "	-	11631	395	26
Jamison2A	5 ¹ / ₄ "	3 ³ / ₈ "	12"	-	1 ¹ / ₄ "	-	11632	363	18
Jamison15	6"	6 ¹ / ₈ "	12"	-	3 ¹ / ₄ "	-	16327	441	31
Jamison3	6 ¹ / ₁₆ "	5 ⁹ / ₁₆ "	12"	5 ¹⁵ / ₁₆ "	2 ¹ / ₂ "	-	11633	414	31
Jamison9	7 ¹ / ₄ "	7 ³ / ₈ "	12"	5 ¹ / ₄ "	5"	4"	11646	609	41
Jamison1	7 ¹ / ₂ "	6 ¹ / ₈ "	12"	-	3 ³ / ₁₆ "	-	9054	552	41
Jamison1A	7 ¹ / ₂ "	8 ¹⁵ / ₁₆ "	12"	-	6"	-	11630	828	58
Jamison8	7 ¹ / ₂ "	4 ¹ / ₄ "	12"	-	1 ¹ / ₄ "	-	11644	435	29
Jamison4	8"	6 ¹ / ₈ "	12"	-	3"	-	11636	624	46
Jamison10	8"	5 ⁹ / ₁₆ "	12"	-	2 ¹ / ₂ "	-	11628	528	37
Jamison13	8 ³ / ₁₆ "	5 ¹ / ₈ "	12"	-	2 ¹ / ₈ "	-	14592	492	35
Jamison5	8 ¹ / ₂ "	8 ¹ / ₈ "	12"	-	4 ⁵ / ₈ "	-	11639	829	62
Jamison14	8 ¹ / ₂ "	8"	12"	-	4 ³ / ₈ "	-	11640	819	60
Jamison16	9"	16"	12"	-	12 ² / ₁₆ "	-	16326	1620	113
Jamison6	10"	6 ¹ / ₄ "	12"	-	3"	-	11641	750	56
Jamison7	12"	7"	12"	-	3 ³ / ₈ "	-	11642	1008	81
Jamison11	12"	5 ⁵ / ₈ "	12"	-	2"	-	11629	792	56

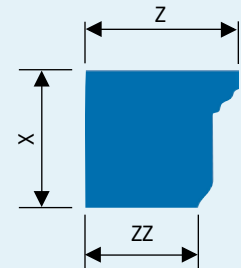
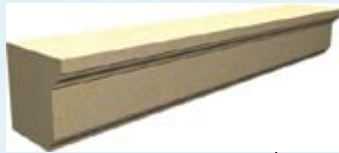

Type Description
Profile

View Modifiers

Surname

Jason

	X	Z	Y	XX	ZZ	P	Unit ID	Cost Factor/Lf	Weight/Lf
Jason6	4"	4 ³ / ₄ "	12"	-	3"	-	16323	359	16
Jason2	4 ¹ / ₂ "	4 ¹¹ / ₁₆ "	12"	-	3"	-	11652	363	19
Jason1	5 ¹ / ₂ "	6 ¹ / ₄ "	12"	-	4 ⁹ / ₁₆ "	-	11649	413	30
Jason1A	5 ¹ / ₂ "	4 ³ / ₄ "	12"	-	3"	-	11651	390	21
Jason3	5 ¹ / ₂ "	8 ¹³ / ₁₆ "	12"	-	7 ¹ / ₁₆ "	-	11653	578	41
Jason4	5 ¹ / ₂ "	3 ¹ / ₄ "	12"	-	1 ¹ / ₂ "	-	11654	356	15
Jason7	7 ¹ / ₂ "	4 ³ / ₄ "	12"	-	3"	-	14568	428	31
Jason5	8"	4 ³ / ₄ "	12"	-	3"	-	14567	456	33

Profiles - The DNA of Stone

Type Description
Profile



View Modifiers

Surname
Jasper

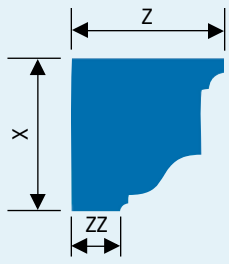

	X	Z	Y	XX	ZZ	P	Unit ID	Cost Factor/Lf	Weight/Lf
Jasper1	9 1/2"	9 1/2"	12"	-	3"	-	15185	1025	72

Type Description
Profile



View Modifiers

Surname
Jerrod

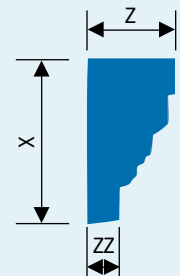

	X	Z	Y	XX	ZZ	P	Unit ID	Cost Factor/Lf	Weight/Lf
Jerrod1	12 3/4"	7"	12"	-	2 1/2"	-	14569	1050	76

Type Description
Profile



View Modifiers

Surname
Jessica

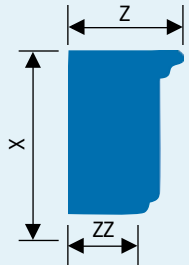

	X	Z	Y	XX	ZZ	P	Unit ID	Cost Factor/Lf	Weight/Lf
Jessica1	6"	4"	12"	-	2"	-	14617	352	21
Jessica2	6 3/4"	5"	12"	-	3"	-	14618	390	29

Type Description
Profile



View Modifiers

Surname
Jewel

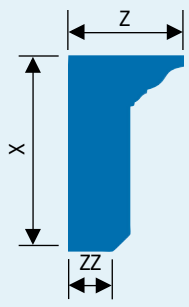

	X	Z	Y	XX	ZZ	P	Unit ID	Cost Factor/Lf	Weight/Lf
Jewel1	11 13/16"	6 5/8"	12"	-	2 1/2"	-	14325	660	49

Profiles - The DNA of Stone



Type Description
Profile

View Modifiers

Surname
Jillian

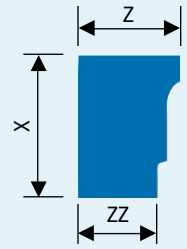

	X	Z	Y	XX	ZZ	P	Unit ID	Cost Factor/Lf	Weight/Lf
Jillian1	7 ³ / ₈ "	5 ¹ / ₂ "	12"	-	4 ¹ / ₄ "	-	11657	506	35
Jillian2	7 ⁵ / ₈ "	5 ¹ / ₂ "	12"	-	2 ¹ / ₈ "	-	11658	500	30



Type Description
Profile

View Modifiers

Surname
Jordan

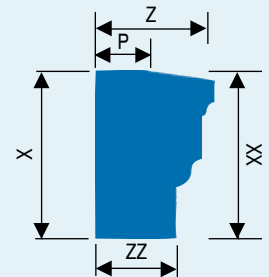

	X	Z	Y	XX	ZZ	P	Unit ID	Cost Factor/Lf	Weight/Lf
Jordan1	9 ³ / ₈ "	7"	12"	8 ⁷ / ₈ "	4 ³ / ₄ "	3"	15352	648	48

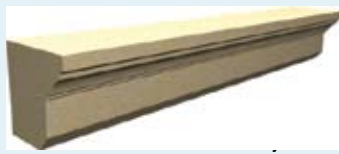

Type Description
Profile

View Modifiers

Surname
Julian

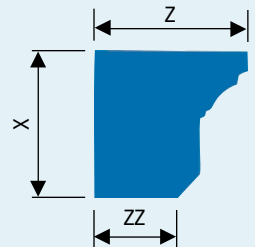

	X	Z	Y	XX	ZZ	P	Unit ID	Cost Factor/Lf	Weight/Lf
Julian2	5 ¹ / ₂ "	4 ⁷ / ₁₆ "	12"	-	1 ¹ / ₂ "	-	11674	375	22
Julian1	6"	6 ¹ / ₂ "	12"	-	3 ¹ / ₂ "	-	11672	468	35
Julian3	6 ¹ / ₂ "	4 ⁷ / ₁₆ "	12"	-	1 ¹ / ₂ "	-	11676	413	26
Julian4	7"	6 ¹ / ₂ "	12"	-	3 ¹ / ₂ "	-	11677	546	40
Julian5	8"	5"	12"	-	1 ¹ / ₂ "	-	11678	480	36
Julian6	8"	6 ¹ / ₂ "	12"	-	3 ¹ / ₂ "	-	12940	576	43
Julian7	8"	4 ⁷ / ₁₆ "	12"	-	1 ¹ / ₂ "	-	16330	384	28
Julian8	8"	18"	12"	-	15"	-	16331	1686	114

Profiles - The DNA of Stone

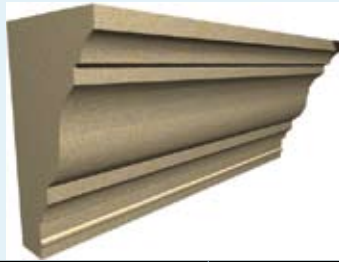

Type Description
Profile

View Modifiers

Surname
Justin

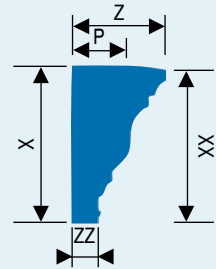

	X	Z	Y	XX	ZZ	P	Unit ID	Cost Factor/Lf	Weight/Lf
Justin9	6"	6 ³ / ₄ "	12"	5 ¹ / ₁₆ "	4 ¹ / ₂ "	3 ¹ / ₂ "	11706	486	36
Justin9A	6"	5"	12"	5 ¹ / ₁₆ "	2 ³ / ₄ "	1 ³ / ₄ "	11707	362	27
Justin13	6"	9 ¹ / ₂ "	12"	5 ¹ / ₁₆ "	7 ¹ / ₄ "	6 ¹ / ₄ "	11687	648	44
Justin14	6"	6 ¹ / ₂ "	12"	5 ¹ / ₁₆ "	4"	5"	11688	468	28
Justin17	6"	4"	12"	-	2 ¹ / ₂ "	-	11680	363	19
Justin19	6"	8"	12"	5 ⁵ / ₈ "	5"	4"	14572	569	42
Justin15	7 ¹ / ₂ "	7"	12"	7 ⁵ / ₁₆ "	4"	5"	11689	630	38
Justin4	8"	8"	12"	7 ⁵ / ₈ "	5"	4"	11698	768	57
Justin5	8"	7 ¹ / ₄ "	12"	7 ¹³ / ₁₆ "	2"	5 ¹ / ₄ "	11700	696	52
Justin10	8"	6"	12"	7 ¹ / ₁₆ "	3"	4"	11683	576	43
Justin11	8"	8"	12"	7 ⁵ / ₈ "	5"	6"	11684	768	57
Justin11A	8"	6"	12"	7 ⁵ / ₈ "	3"	4"	14552	576	43
Justin12	8"	18"	12"	-	14 ¹ / ₂ "	-	11686	1528	117
Justin18	8"	6 ³ / ₄ "	12"	-	4 ¹ / ₂ "	3 ¹ / ₂ "	11693	597	44
Justin3	10"	7 ¹ / ₄ "	12"	9 ¹³ / ₁₆ "	3 ³ / ₄ "	5 ¹ / ₈ "	11696	870	65
Justin3A	10"	12 ³ / ₈ "	12"	9 ¹³ / ₁₆ "	6 ¹ / ₄ "	10 ¹ / ₄ "	11697	1486	111
Justin16	10"	7 ¹ / ₂ "	12"	9 ¹ / ₁₆ "	4"	5 ³ / ₈ "	11691	900	54
Justin7	11"	6"	12"	10 ¹³ / ₁₆ "	1 ¹³ / ₁₆ "	3 ³ / ₈ "	11702	792	59
Justin8	12"	9 ⁵ / ₈ "	12"	11 ¹¹ / ₁₆ "	5"	4 ¹ / ₄ "	11703	1392	104
Justin2	12 ¹ / ₂ "	7 ¹ / ₄ "	12"	12 ¹ / ₄ "	2"	5 ¹ / ₄ "	11695	1088	81
Justin1	16 ¹ / ₁₆ "	10"	12"	15 ⁷ / ₈ "	3"	7 ¹ / ₄ "	11682	1920	144

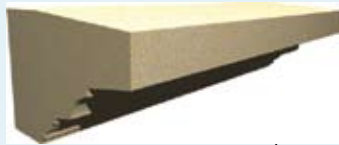

Type Description
Profile

View Modifiers

Surname
Maeve

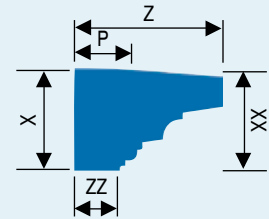

	X	Z	Y	XX	ZZ	P	Unit ID	Cost Factor/Lf	Weight/Lf
Maeve1	9"	13"	12"	8 ¹ / ₄ "	4"	4"	11768	1080	74

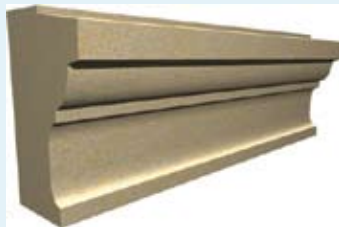

Type Description
Profile

View Modifiers

Surname
Maidstone

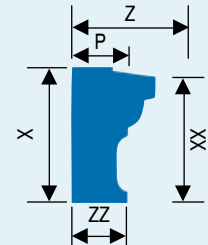

	X	Z	Y	XX	ZZ	P	Unit ID	Cost Factor/Lf	Weight/Lf
Maidstone3	9 ¹ / ₂ "	8"	12"	9"	5 ³ / ₈ "	4"	15264	912	66
Maidstone1	12 ¹¹ / ₁₆ "	7 ¹⁵ / ₁₆ "	12"	11 ¹¹ / ₁₆ "	5 ⁵ / ₈ "	4"	11769	1074	73
Maidstone2	12 ³ / ₄ "	8"	12"	11 ³ / ₄ "	5 ¹ / ₂ "	3 ¹ / ₄ "	11770	1074	70

Profiles - The DNA of Stone

Type Description
Profile

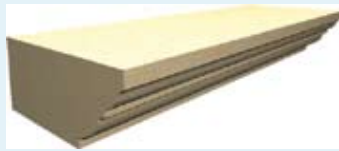

View Modifiers Surname
Maine

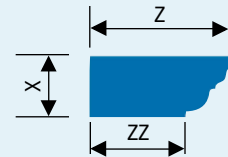

	X	Z	Y	XX	ZZ	P	Unit ID	Cost Factor/Lf	Weight/Lf
Maine1	5 ⁷ / ₁₆ "	12 ¹ / ₂ "	12"	-	8 ¹ / ₂ "	-	11772	825	54

Type Description
Profile

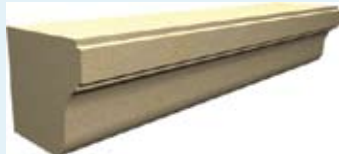

View Modifiers Surname
Manor

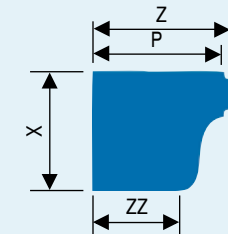

	X	Z	Y	XX	ZZ	P	Unit ID	Cost Factor/Lf	Weight/Lf
Manor1	7"	8 ³ / ₈ "	12"	-	5 ⁷ / ₁₆ "	7 ¹⁵ / ₁₆ "	11774	704	48
Manor2	11"	12 ¹⁵ / ₁₆ "	12"	-	8 ³ / ₈ "	12 ⁵ / ₁₆ "	11775	1308	109

Type Description
Profile



View Modifiers Surname
Marcus

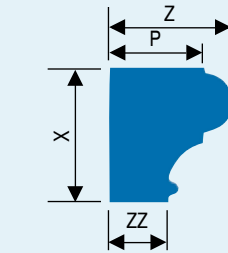

	X	Z	Y	XX	ZZ	P	Unit ID	Cost Factor/Lf	Weight/Lf
Marcus3	6"	5 ¹ / ₂ "	12"	-	2 ³ / ₄ "	4 ¹ / ₄ "	11783	396	29
Marcus3A	6"	4 ¹ / ₄ "	12"	-	1 ¹ / ₂ "	3"	11785	352	19
Marcus4	8"	6 ¹ / ₂ "	12"	-	3"	4 ³ / ₄ "	11788	624	47
Marcus4A	8"	5 ³ / ₄ "	12"	-	2 ¹ / ₄ "	4"	11789	509	36
Marcus10	8"	5 ¹ / ₂ "	12"	-	2 ¹¹ / ₁₆ "	4 ³ / ₁₆ "	16342	499	35
Marcus2	8 ³ / ₄ "	5 ¹ / ₂ "	12"	-	2 ¹¹ / ₁₆ "	4 ³ / ₁₆ "	16343	510	35
Marcus5	10"	7 ¹ / ₂ "	12"	-	3 ¹ / ₂ "	5"	11790	900	67
Marcus9	10"	5 ¹ / ₂ "	12"	-	2 ³ / ₄ "	4 ¹ / ₄ "	16340	660	48
Marcus9A	10"	7 ³ / ₄ "	12"	-	5"	6 ¹ / ₂ "	16341	899	63
Marcus8	11 ¹ / ₂ "	5 ¹ / ₂ "	12"	-	2 ¹¹ / ₁₆ "	4 ³ / ₁₆ "	16344	690	51
Marcus1	12"	10 ³ / ₄ "	12"	-	8 ⁵ / ₁₆ "	5 ¹ / ₄ "	14377	1512	103
Marcus6	12"	8 ¹ / ₂ "	12"	-	4"	5"	11791	1224	91
Marcus11	12"	8 ³ / ₄ "	12"	-	4 ³ / ₈ "	6 ³ / ₄ "	16338	1253	88
Marcus7	12 ¹ / ₄ "	8 ³ / ₄ "	12"	-	4 ³ / ₈ "	6 ³ / ₄ "	11793	1287	96

Profiles - The DNA of Stone

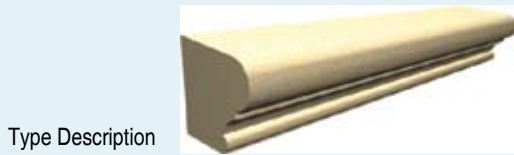

Type Description
Profile

View Modifiers

Surname

MarcusSlope

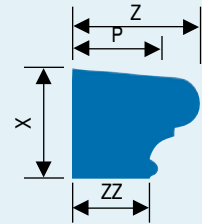

	X	Z	Y	XX	ZZ	P	Unit ID	Cost Factor/Lf	Weight/Lf
MarcusSlope3	6 1/4"	9"	12"	6"	6"	7 1/2"	11796	653	46
MarcusSlope4	6 1/4"	4 1/4"	12"	6"	1 1/4"	3"	15307	375	24
MarcusSlope1	6 1/2"	7 3/4"	12"	6"	4 3/4"	6 1/4"	9427	605	45
MarcusSlope5	6 1/2"	6 3/4"	12"	6"	3 3/4"	5 1/4"	14520	526	39
MarcusSlope6	6 1/2"	8 3/8"	12"	6"	5 3/8"	6 7/8"	14590	648	48
MarcusSlope7	6 1/2"	9 1/4"	12"	6"	6 1/4"	1 1/2"	16410	702	53
MarcusSlope2	6 7/8"	5 1/2"	12"	6 1/2"	2 1/4"	4 1/4"	11795	474	35



Type Description
Profile

View Modifiers

Surname

Maris

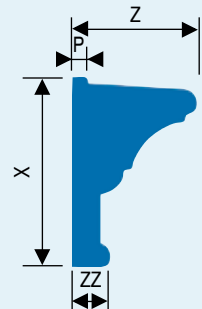

	X	Z	Y	XX	ZZ	P	Unit ID	Cost Factor/Lf	Weight/Lf
Maris1	9 3/8"	6 5/8"	12"	-	1 13/16"	7/8"	15354	557	41
Maris2	10 3/4"	7 1/2"	12"	-	1 13/16"	7/8"	15361	645	48



Type Description
Profile

View Modifiers

Surname

Marsalla

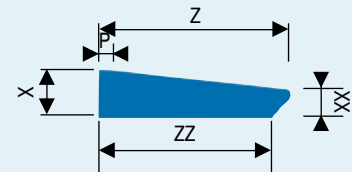

	X	Z	Y	XX	ZZ	P	Unit ID	Cost Factor/Lf	Weight/Lf
Marsalla1	3"	12 1/16"	12"	1 7/8"	10"	3/4"	9466	488	29



Type Description
Profile

View Modifiers

Surname

Marsanne

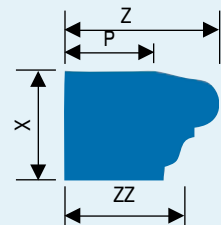

	X	Z	Y	XX	ZZ	P	Unit ID	Cost Factor/Lf	Weight/Lf
Marsanne2	5 1/2"	9 3/4"	12"	-	6 15/16"	8 1/2"	16438	614	43
Marsanne1	5 5/8"	8"	12"	-	5 1/4"	4 3/4"	10180	545	36

Profiles - The DNA of Stone

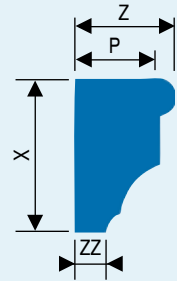

Type Description
Profile

View Modifiers

Surname

Marshall

	X	Z	Y	XX	ZZ	P	Unit ID	Cost Factor/Lf	Weight/Lf
Marshall14	3 ¹ / ₁₆ "	3 ¹ / ₂ "	12"	-	1 ¹ / ₁₆ "	2 ⁷ / ₈ "	16279	350	8
Marshall16	4"	3 ¹ / ₂ "	12"	-	1 ⁹ / ₁₆ "	3"	16415	351	13
Marshall2	6"	5 ¹ / ₂ "	12"	-	1 ³ / ₄ "	4 ⁵ / ₈ "	11829	396	29
Marshall2A	6"	7"	12"	-	3 ¹ / ₄ "	6 ¹ / ₈ "	11832	504	36
Marshall2B	6"	6 ¹ / ₄ "	12"	-	2 ¹ / ₂ "	5"	14583	401	31
Marshall5	6"	3 ¹ / ₂ "	12"	-	1 ⁵ / ₈ "	2 ¹⁵ / ₁₆ "	11835	364	18
Marshall9	6"	9"	12"	-	4 ¹ / ₂ "	8"	14584	639	47
Marshall11	6"	6 ¹ / ₂ "	12"	-	2 ¹¹ / ₁₆ "	5 ¹ / ₂ "	16411	401	29
Marshall15	6"	3 ¹ / ₂ "	12"	-	1 ⁹ / ₁₆ "	3"	16414	353	18
Marshall12	7 ³ / ₄ "	8"	12"	-	3 ¹ / ₂ "	6 ³ / ₈ "	16412	722	52
Marshall1	8"	5 ¹ / ₂ "	12"	-	1 ³ / ₄ "	4 ⁵ / ₈ "	11820	528	39
Marshall1A	8"	7"	12"	-	3 ¹ / ₄ "	6 ¹ / ₈ "	11825	672	49
Marshall6	8"	3 ¹ / ₂ "	12"	-	1 ⁵ / ₈ "	2 ¹⁵ / ₁₆ "	11836	453	22
Marshall8	8"	9"	12"	-	4 ¹ / ₂ "	8"	14565	859	64
Marshall3	10"	5 ⁵ / ₈ "	12"	-	1 ³ / ₄ "	4 ⁵ / ₈ "	11833	681	51
Marshall7	10"	7"	12"	-	3 ¹ / ₄ "	6 ¹ / ₈ "	11837	840	61
Marshall10	11"	5 ⁵ / ₈ "	12"	-	1 ¹³ / ₁₆ "	4 ⁵ / ₈ "	14588	698	52
Marshall13	11 ¹⁵ / ₁₆ "	5 ¹¹ / ₁₆ "	12"	-	1 ¹³ / ₁₆ "	4 ⁹ / ₁₆ "	16413	792	57
Marshall4	12"	7 ¹ / ₂ "	12"	-	2 ³ / ₄ "	4 ¹ / ₄ "	11834	1080	81

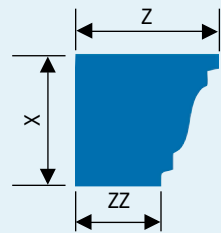
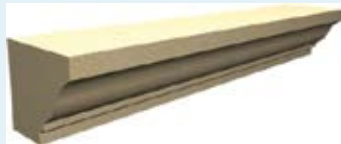

Type Description
Profile

View Modifiers

Surname

Marsten

	X	Z	Y	XX	ZZ	P	Unit ID	Cost Factor/Lf	Weight/Lf
Marsten2	7"	8"	12"	-	4 ¹ / ₂ "	-	9640	672	41
Marsten3	6"	7 ³ / ₄ "	12"	-	4"	-	11839	531	33
Marsten4	5 ³ / ₄ "	7"	12"	-	2"	-	11840	462	27
Marsten1	8"	8 ⁵ / ₁₆ "	12"	-	5 ⁵ / ₁₆ "	-	11838	804	51

Profiles - The DNA of Stone

Type Description Profile



View Modifiers

Surname **Martin**

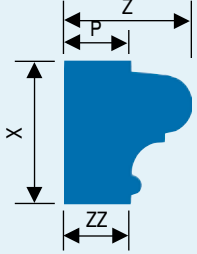

	X	Z	Y	XX	ZZ	P	Unit ID	Cost Factor/Lf	Weight/Lf
Martin1	7 ⁵ / ₈ "	6 ³ / ₄ "	12"	-	3 ¹ / ₂ "	3 ¹ / ₂ "	16435	618	45
Martin1A	7 ⁵ / ₈ "	5 ³ / ₄ "	12"	-	2 ¹ / ₂ "	1"	16436	524	38
Martin2	7 ⁵ / ₈ "	8 ¹ / ₄ "	12"	-	5"	1 ¹ / ₂ "	16437	661	49

Type Description Profile

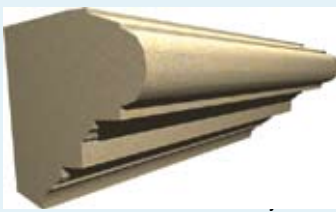

View Modifiers

Surname **Maxmillian**

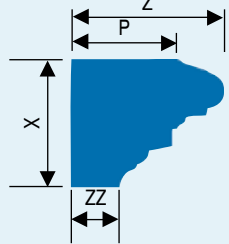

	X	Z	Y	XX	ZZ	P	Unit ID	Cost Factor/Lf	Weight/Lf
Maxmillian1	15"	18"	12"	-	5 ¹ / ₂ "	11"	15184	2160	151

Type Description Profile



View Modifiers

Surname **Maxwell**

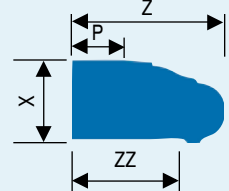

	X	Z	Y	XX	ZZ	P	Unit ID	Cost Factor/Lf	Weight/Lf
Maxwell1	5 ¹ / ₂ "	10 ³ / ₄ "	12"	-	7 ¹³ / ₁₆ "	5 ³ / ₄ "	11843	742	55
Maxwell1A	5 ¹ / ₂ "	7"	12"	-	4 ¹ / ₁₆ "	2"	11844	483	36
Maxwell1B	5 ³ / ₄ "	8"	12"	-	5 ¹ / ₁₆ "	3"	15183	528	39

Type Description Profile

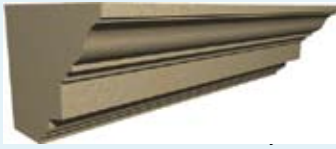

View Modifiers

Surname **Mayfair**

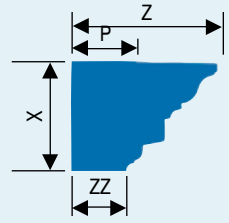

	X	Z	Y	XX	ZZ	P	Unit ID	Cost Factor/Lf	Weight/Lf
Mayfair1	9 ³ / ₈ "	13"	12"	-	4 ³ / ₄ "	3 ¹ / ₂ "	14963	1404	102

Profiles - The DNA of Stone

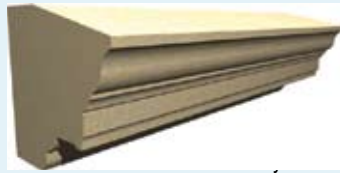

Type Description
Profile

View Modifiers

Surname
Mayfield

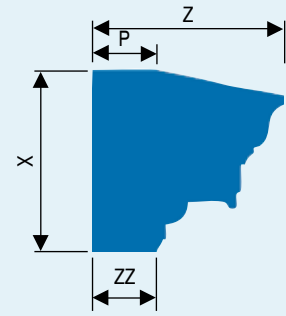

	X	Z	Y	XX	ZZ	P	Unit ID	Cost Factor/Lf	Weight/Lf
Mayfield1	10 ¹ / ₂ "	11 ¹ / ₄ "	12"	9"	3 ³ / ₄ "	3 ⁵ / ₈ "	11852	1386	91



Type Description
Profile

View Modifiers

Surname
Megan

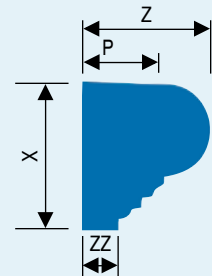

	X	Z	Y	XX	ZZ	P	Unit ID	Cost Factor/Lf	Weight/Lf
Megan1	7 ¹ / ₄ "	8 ¹ / ₂ "	12"	7"	4"	6 ¹ / ₄ "	11868	740	42
Megan1A	7 ¹ / ₄ "	6 ³ / ₈ "	12"	7"	1 ¹ / ₈ "	4 ¹ / ₈ "	11869	555	28
Megan1B	7 ¹ / ₄ "	13"	12"	7"	8 ¹ / ₂ "	10 ³ / ₄ "	11870	1131	80
Megan2	7 ¹ / ₂ "	12 ¹ / ₂ "	12"	7 ¹ / ₄ "	8"	10 ⁵ / ₁₆ "	11871	1125	72
Megan3	7 ¹ / ₂ "	14"	12"	7 ¹ / ₄ "	9 ¹ / ₂ "	11 ¹³ / ₁₆ "	11872	1260	81

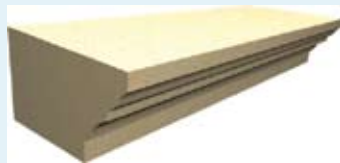

Type Description
Profile

View Modifiers

Surname
Mende

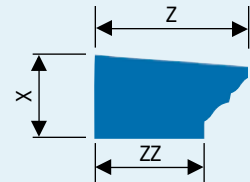

	X	Z	Y	XX	ZZ	P	Unit ID	Cost Factor/Lf	Weight/Lf
Mende1	7"	12 ⁵ / ₈ "	12"	6"	9"	-	11876	1060	69

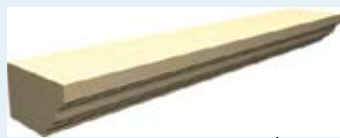

Type Description
Profile

View Modifiers

Surname
Miller

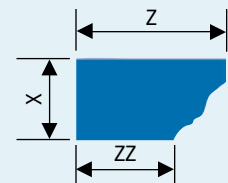

	X	Z	Y	XX	ZZ	P	Unit ID	Cost Factor/Lf	Weight/Lf
Miller1	3 ¹ / ₂ "	9 ³ / ₄ "	12"	-	7 ¹ / ₂ "	-	11880	410	29
Miller1A	3 ¹ / ₂ "	8"	12"	-	5 ⁵ / ₈ "	-	11882	377	22
Miller1B	3 ¹ / ₂ "	6 ¹ / ₂ "	12"	-	4 ¹ / ₄ "	-	14728	362	20
Miller2	3 ¹ / ₂ "	11"	12"	-	8 ³ / ₄ "	-	15180	462	33

301 Pleasant Drive • Dallas, TX 75217
(800) 398-1199 • FAX (214) 398-1293
www.stonelegends.com • sales@stonelegends.com

STONE LEGENDS

Profiles - The DNA of Stone

Type Description
Profile

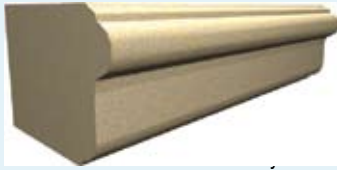

View Modifiers

Surname
Modesto

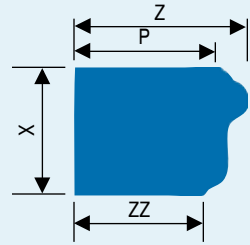

	X	Z	Y	XX	ZZ	P	Unit ID	Cost Factor/Lf	Weight/Lf
Modesto1	10"	14"	12"	-	10 1/4"	11 3/4"	15359	1620	122

Type Description
Profile

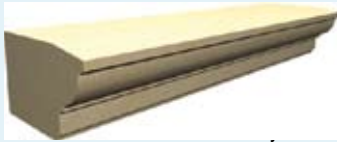

View Modifiers

Surname
Myriad

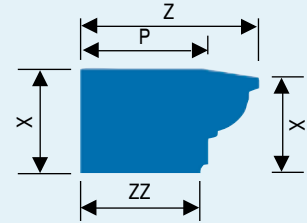

	X	Z	Y	XX	ZZ	P	Unit ID	Cost Factor/Lf	Weight/Lf
Myriad1	6"	10 1/2"	12"	5 3/4"	7"	7"	15378	648	49

Type Description
Profile



View Modifiers

Surname
Nathan

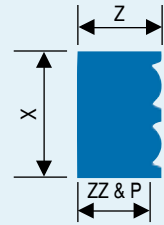

	X	Z	Y	XX	ZZ	P	Unit ID	Cost Factor/Lf	Weight/Lf
Nathan1	8 1/16"	5 5/16"	12"	-	5 7/16"	5 7/16"	14591	578	44

Type Description
Profile

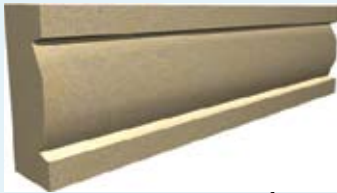

View Modifiers

Surname
Navarro

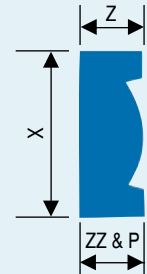

	X	Z	Y	XX	ZZ	P	Unit ID	Cost Factor/Lf	Weight/Lf
Navarro5	4 3/4"	4 1/4"	12"	-	4 1/4"	4 1/4"	11904	353	18
Navarro4	6"	6"	12"	-	6"	6"	11903	432	32
Navarro8	6"	4 1/4"	12"	-	4 1/4"	4 1/4"	11906	390	23
Navarro3	8"	6"	12"	-	6"	6"	11901	576	43
Navarro6	8"	3 1/2"	12"	-	3 1/2"	3 1/2"	9135	400	25
Navarro7	8"	4 1/4"	12"	-	4 1/4"	4 1/4"	11905	414	30
Navarro2	10"	4 1/4"	12"	-	4 1/4"	4 1/4"	11899	510	38
Navarro1	12"	4 1/4"	12"	-	4 1/4"	4 1/4"	9130	648	48

Profiles - The DNA of Stone

Type Description Profile



View Modifiers Surname **Neon**

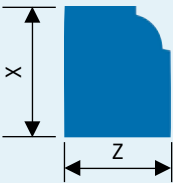

	X	Z	Y	XX	ZZ	P	Unit ID	Cost Factor/Lf	Weight/Lf
Neon1	5 ¹ / ₈ "	4 ³ / ₈ "	12"	-	-	3 ¹ / ₈ "	15980	360	22

Type Description Profile

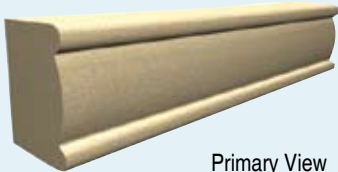

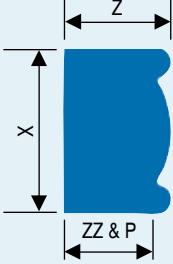

Primary View View Modifiers Surname **Nexus**

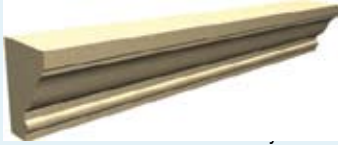

	X	Z	Y	XX	ZZ	P	Unit ID	Cost Factor/Lf	Weight/Lf
Nexus2	8"	6 ¹ / ₂ "	12"	-	5"	5"	11922	624	46
Nexus2A	8"	5 ¹ / ₂ "	12"	-	4"	4"	9140	528	39
Nexus3	8"	3 ¹ / ₂ "	12"	-	2 ³ / ₄ "	2 ³ / ₄ "	9141	355	25
Nexus1	12"	5 ¹ / ₂ "	12"	-	4"	4"	11921	792	59

Type Description Profile



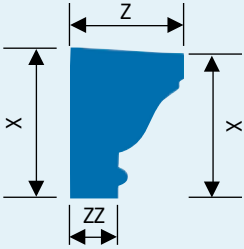

View Modifiers Surname **O'Donnell**

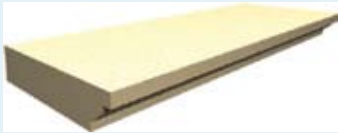

	X	Z	Y	XX	ZZ	P	Unit ID	Cost Factor/Lf	Weight/Lf
O'Donnell1	5 ⁷ / ₈ "	5 ¹ / ₂ "	12"	5 ⁷ / ₈ "	2 ¹⁵ / ₁₆ "	-	11955	437	29
O'Donnell3	5 ¹ / ₈ "	4 ³ / ₁₆ "	12"	5 ⁷ / ₈ "	1 ¹⁵ / ₁₆ "	-	14535	352	23
O'Donnell2	6"	5"	12"	-	2 ⁵ / ₁₆ "	-	11956	410	27

Type Description Profile



View Modifiers Surname **Oak**

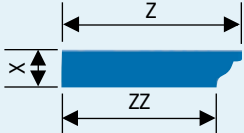

	X	Z	Y	XX	ZZ	P	Unit ID	Cost Factor/Lf	Weight/Lf
Oak1	3"	14 ¹ / ₄ "	12"	-	12 ¹ / ₄ "	-	11957	513	41
Oak1A	3"	12 ¹ / ₄ "	12"	-	10 ¹ / ₄ "	-	11958	441	35
Oak2	3"	3"	12"	1"	3"	1"	11959	350	8
Oak3	5"	6 ¹ / ₂ "	12"	-	2 ³ / ₄ "	-	16136	360	26

301 Pleasant Drive • Dallas, TX 75217
 (800) 398-1199 • FAX (214) 398-1293
 www.stonelegends.com • sales@stonelegends.com

STONE LEGENDS

Profiles - The DNA of Stone

Type Description
Profile



View Modifiers

Surname

Oceania

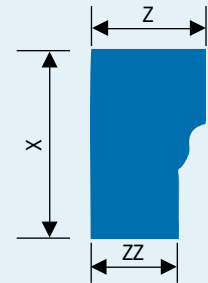

	X	Z	Y	XX	ZZ	P	Unit ID	Cost Factor/Lf	Weight/Lf
Oceania1	6 ⁵ / ₈ "	4 ¹ / ₄ "	12"	-	3 ¹ / ₄ "	-	15981	351	23

Type Description
Profile

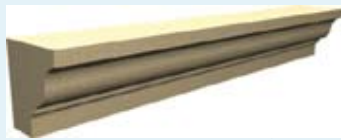

View Modifiers

Surname

Odessa

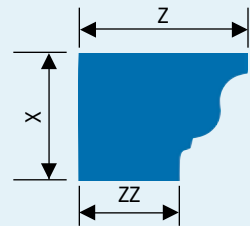

	X	Z	Y	XX	ZZ	P	Unit ID	Cost Factor/Lf	Weight/Lf
Odessa3	5 ¹ / ₂ "	10 ¹ / ₂ "	12"	-	6 ³ / ₄ "	-	16472	693	49
Odessa1	6 ¹ / ₄ "	6"	12"	-	2 ³ / ₄ "	-	16470	450	31
Odessa2	6 ¹ / ₄ "	11 ¹ / ₂ "	12"	-	8 ¹ / ₄ "	-	16471	862	63

Type Description
Profile

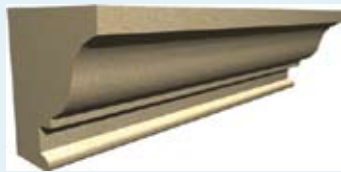

View Modifiers

Surname

Odyssey

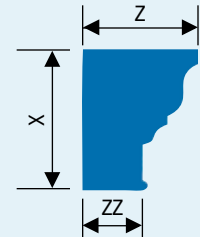

	X	Z	Y	XX	ZZ	P	Unit ID	Cost Factor/Lf	Weight/Lf
Odyssey1	8"	6 ³ / ₄ "	12"	-	3 ³ / ₈ "	-	11965	648	42
Odyssey1A	8"	5"	12"	-	1 ⁵ / ₈ "	-	11966	480	27
Odyssey1B	8"	11 ⁷ / ₁₆ "	12"	-	8 ¹ / ₂ "	-	14536	1056	79
Odyssey1C	8"	7 ³ / ₈ "	12"	-	4"	-	16351	672	51
Odyssey3	9"	6 ³ / ₄ "	12"	-	3 ³ / ₈ "	-	16353	648	48
Odyssey4	10"	7 ³ / ₈ "	12"	-	3 ³ / ₈ "	-	16350	840	63
Odyssey6	10"	8"	12"	-	4 ¹ / ₂ "	-	16352	878	65
Odyssey2	10 ¹ / ₄ "	10"	12"	-	3 ¹ / ₂ "	-	11968	1230	92
Odyssey2A	10 ¹ / ₄ "	19"	12"	-	12 ¹ / ₂ "	-	11969	2160	161
Odyssey5	10 ³ / ₈ "	7 ¹ / ₄ "	12"	-	4"	-	16354	889	66

Profiles - The DNA of Stone

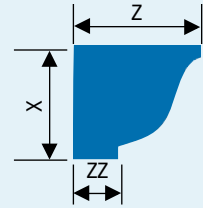

Type Description
Profile

View Modifiers

Surname

Ogee

	X	Z	Y	XX	ZZ	P	Unit ID	Cost Factor/Lf	Weight/Lf
Ogee5	3 ⁵ / ₈ "	5 ¹ / ₈ "	12"	-	4 ¹ / ₈ "	-	12035	350	16
Ogee4	3 ³ / ₄ "	6 ¹ / ₂ "	12"	-	5"	-	12029	395	22
Ogee6	3 ³ / ₄ "	5 ³ / ₄ "	12"	-	3 ³ / ₄ "	-	12037	350	19
Ogee7	3 ⁷ / ₈ "	5 ¹ / ₈ "	12"	-	3 ¹ / ₂ "	-	14748	351	19
Ogee9	4"	5 ⁵ / ₈ "	12"	-	4 ³ / ₁₆ "	-	14747	362	19
Ogee11	4"	7 ³ / ₄ "	12"	-	5 ³ / ₄ "	-	11998	372	28
Ogee12	4 ¹ / ₂ "	10 ³ / ₈ "	12"	-	8 ⁷ / ₈ "	-	12000	561	42
Ogee13A	4 ⁵ / ₁₆ "	3 ⁷ / ₁₆ "	12"	-	2 ⁷ / ₁₆ "	-	14537	350	15
Ogee20	4"	10 ¹ / ₂ "	12"	-	8 ¹ / ₂ "	-	16422	558	41
Ogee14	5"	8"	12"	-	6"	-	12003	480	36
Ogee14A	5"	6 ³ / ₄ "	12"	-	4 ³ / ₄ "	-	12004	420	30
Ogee3	5"	8"	12"	-	6"	-	12024	480	36
Ogee3A	5"	6"	12"	-	4"	-	12027	420	30
Ogee13	5"	5"	12"	-	4"	-	12001	370	22
Ogee22	5"	7 ¹ / ₄ "	12"	-	5 ¹ / ₄ "	-	16423	422	31
Ogee23	5"	10 ⁹ / ₁₆ "	12"	-	8 ¹⁵ / ₁₆ "	-	16424	603	45
Ogee15	5 ¹ / ₂ "	11 ¹ / ₄ "	12"	-	8 ³ / ₈ "	-	9649	743	55
Ogee15A	5 ¹ / ₂ "	10 ¹ / ₂ "	12"	-	7 ⁵ / ₈ "	-	12008	602	41
Ogee19	6 ³ / ₁₆ "	6"	12"	-	3"	-	9152	468	35
Ogee18	6"	5 ³ / ₈ "	12"	-	2 ¹ / ₄ "	-	12013	410	28
Ogee16	6 ¹ / ₂ "	7 ³ / ₄ "	12"	-	4 ³ / ₄ "	-	12009	605	45
Ogee16A	6 ¹ / ₂ "	9"	12"	-	6"	-	12011	698	51
Ogee17	7"	8"	12"	-	5"	-	12012	672	50
Ogee2	7 ⁵ / ₈ "	9"	12"	-	6"	-	12016	828	62
Ogee30	7 ⁵ / ₈ "	9"	12"	-	3 ⁵ / ₈ "	-	12025	824	65
Ogee25	7 ³ / ₄ "	4 ¹ / ₈ "	12"	-	1 ¹ / ₂ "	-	12018	384	28
Ogee21	7 ¹¹ / ₁₆ "	10 ³ / ₄ "	12"	-	8 ¹ / ₄ "	-	9650	998	75
Ogee8	8"	5 ¹ / ₂ "	12"	-	3 ¹ / ₂ "	-	14534	528	34
Ogee10	8"	7 ³ / ₄ "	12"	-	3 ³ / ₄ "	-	16420	718	52
Ogee24	8"	8"	12"	-	5"	-	9153	768	57
Ogee26	8"	4"	12"	-	1 ¹ / ₁₆ "	-	12019	355	18
Ogee27	8 ¹ / ₂ "	4"	12"	-	1 ¹¹ / ₁₆ "	-	12020	479	34
Ogee1	9"	12"	12"	-	6 ¹ / ₂ "	-	11997	1296	97
Ogee29	9 ⁵ / ₈ "	15"	12"	-	11"	-	12022	1740	130
Ogee28	14"	8"	12"	-	5"	-	12021	1344	100

Profiles - The DNA of Stone



Type Description
Profile

View Modifiers

Surname
OgeeSlope

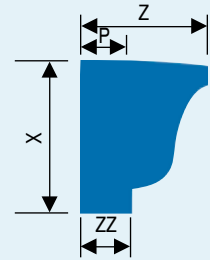

	X	Z	Y	XX	ZZ	P	Unit ID	Cost Factor/Lf	Weight/Lf
OgeeSlope1	2 1/2"	11"	12"	2 1/8"	9 7/16"	2 7/8"	12066	396	25
OgeeSlope9	4 1/4"	9"	12"	4"	6 7/8"	5"	12074	459	34
OgeeSlope10	4 5/8"	9"	12"	4"	6 7/8"	5"	12067	496	36
OgeeSlope2	5 3/4"	4 7/8"	12"	5 1/2"	1 15/16"	1 1/4"	12068	381	25
OgeeSlope3	5 3/4"	6 3/4"	12"	5 3/8"	4"	-	12069	466	35
OgeeSlope4	5 3/4"	10 13/16"	12"	4 13/16"	9"	3/4"	12070	732	55
OgeeSlope4A	5 3/8"	6 1/16"	12"	4 3/16"	4 1/4"	3/4"	12071	408	31
OgeeSlope15	6"	6"	12"	5 3/8"	4"	-	15501	396	28
OgeeSlope5	6 1/8"	12 1/8"	12"	5 7/16"	9 3/8"	-	14737	893	67
OgeeSlope11	6 1/8"	13 1/16"	12"	5 7/16"	10 3/8"	4"	14722	936	69
OgeeSlope13	6 1/2"	8 1/4"	12"	5 1/2"	5"	-	14998	576	42
OgeeSlope6	7 5/8"	8 1/16"	12"	7 1/16"	5 1/8"	2"	12072	737	55
OgeeSlope12	7 3/4"	6"	12"	6 3/4"	3 3/4"	1"	15182	540	39
OgeeSlope14	8"	17 5/8"	12"	5"	14 1/8"	-	14799	1428	99
OgeeSlope7	8 1/2"	7 3/4"	12"	6 7/16"	2 3/16"	-	9437	791	59
OgeeSlope8	12"	4 3/4"	12"	11 3/4"	3"	1"	12073	468	35



Type Description
Profile

View Modifiers

Surname
Ogent

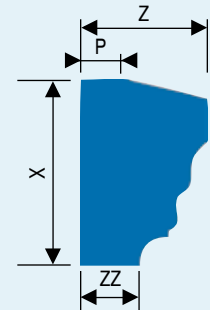

	X	Z	Y	XX	ZZ	P	Unit ID	Cost Factor/Lf	Weight/Lf
Ogent1	9 3/4"	7"	12"	8 3/4"	3 1/4"	2"	15356	798	56

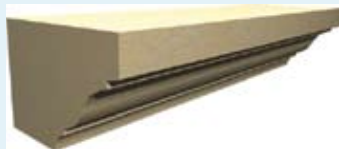

Type Description
Profile

View Modifiers

Surname
Oлга

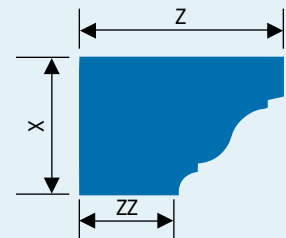

	X	Z	Y	XX	ZZ	P	Unit ID	Cost Factor/Lf	Weight/Lf
Olga1	8"	12"	12"	-	5 3/4"	-	15308	984	71

Profiles - The DNA of Stone

Type Description
Profile

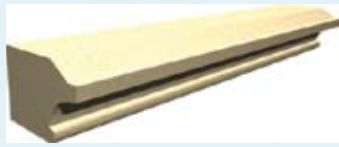

View Modifiers

Surname

Olla

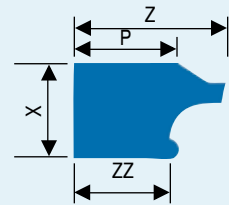

	X	Z	Y	XX	ZZ	P	Unit ID	Cost Factor/Lf	Weight/Lf
Olla1	5"	8"	12"	-	5"	5 1/2"	15208	420	31

Type Description
Profile



View Modifiers

Surname

Oneida

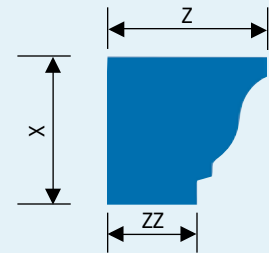

	X	Z	Y	XX	ZZ	P	Unit ID	Cost Factor/Lf	Weight/Lf
Oneida7	6 7/8"	5 1/2"	12"	-	4"	-	12103	402	30
Oneida3	7"	8"	12"	-	4 1/2"	-	12098	672	44
Oneida4	7"	20"	12"	-	16 1/8"	-	12099	1512	115
Oneida6	7"	5 1/2"	12"	-	4"	-	14719	462	31
Oneida5	7 5/8"	12 1/2"	12"	-	10"	-	12100	1144	80
Oneida5A	7 5/8"	7 1/2"	12"	-	5"	-	12101	686	46
Oneida10	8"	4 1/2"	12"	-	3"	-	16357	384	27
Oneida2	8 1/8"	8 1/2"	12"	-	4 1/2"	-	12097	829	55
Oneida1	8 7/8"	7 1/8"	12"	-	4 3/16"	-	12096	759	49
Oneida8	10"	8"	12"	-	4 1/2"	-	16355	840	63
Oneida9	11 3/8"	8"	12"	-	5 1/8"	-	16356	1056	77

Type Description
Profile



View Modifiers

Surname

Oracle

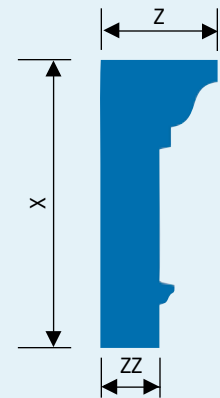

	X	Z	Y	XX	ZZ	P	Unit ID	Cost Factor/Lf	Weight/Lf
Oracle1	9 3/4"	4"	12"	-	2"	-	15244	351	24

Profiles - The DNA of Stone

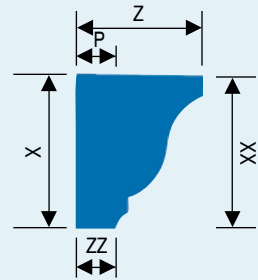

Type Description
Profile

View Modifiers

Surname

Oriel

	X	Z	Y	XX	ZZ	P	Unit ID	Cost Factor/Lf	Weight/Lf
Oriel13	3 1/2"	7"	12"	-	4"	-	12115	350	19
Oriel1	4"	3 11/16"	12"	-	1 1/16"	-	12111	363	13
Oriel12	4 3/4"	16"	12"	-	12 1/2"	-	12114	912	68
Oriel18	5"	6"	12"	4 3/4"	3 3/4"	-	12120	445	24
Oriel2	5 1/2"	8"	12"	5 1/4"	4 1/2"	4 1/2"	12123	528	29
Oriel16	5 1/2"	7"	12"	-	4"	-	12118	462	30
Oriel15	5 7/16"	3 7/16"	12"	5"	2"	3/4"	12117	386	18
Oriel3	6"	4 15/16"	12"	5 15/16"	1 9/16"	-	12129	408	27
Oriel4	6"	8"	12"	5 3/4"	4 9/16"	4 7/16"	12130	576	36
Oriel17	6 1/4"	11"	12"	-	7 3/8"	-	12119	825	56
Oriel17A	6 1/4"	6 1/16"	12"	-	2 7/16"	-	15210	446	33
Oriel5	6 7/16"	8 3/16"	12"	5 7/16"	4"	3 3/8"	12132	644	38
Oriel5A	6 7/16"	12"	12"	5 7/16"	9 9/16"	6 7/8"	14539	1152	84
Oriel6	6 1/2"	11 7/8"	12"	6"	8 1/2"	-	9442	926	63
Oriel7	7"	9 9/16"	12"	5 7/16"	5 1/16"	-	12133	777	49
Oriel8	7 1/2"	8"	12"	6 1/2"	3 3/8"	3 3/8"	12134	720	44
Oriel19	7 1/2"	11"	12"	7"	6"	6"	12121	990	60
Oriel20	7 1/2"	11"	12"	-	6"	-	12124	990	62
Oriel9	12"	15 3/8"	12"	-	9 13/16"	-	12135	2215	166
Oriel10	12 1/8"	12 7/8"	12"	10 7/16"	4 7/16"	4 1/8"	12112	1872	140
Oriel11	13 5/8"	7 3/8"	12"	-	1 3/8"	-	12113	1215	91
Oriel14	16"	7 1/2"	12"	-	3 5/8"	-	9654	1323	92

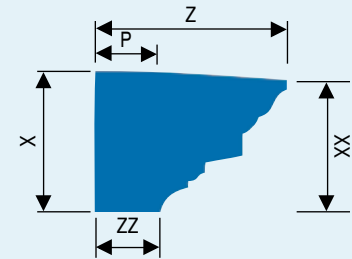
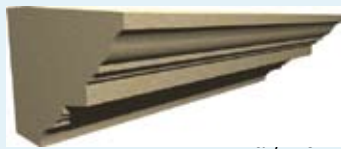

Type Description
Profile

View Modifiers

Surname

Orlando

	X	Z	Y	XX	ZZ	P	Unit ID	Cost Factor/Lf	Weight/Lf
Orlando4	7"	10"	12"	6 1/4"	4"	4"	12150	840	46
Orlando3	10 1/2"	15"	12"	9 3/4"	4 5/8"	4"	12149	1260	97
Orlando6	10 1/2"	14 1/4"	12"	9 3/4"	7"	4"	12152	1404	103
Orlando6A	10 1/2"	12 3/4"	12"	9 3/4"	5 1/2"	4"	12153	1320	96
Orlando5	10 3/4"	11 1/8"	12"	10"	4 7/8"	4 7/8"	12151	1205	92
Orlando1	12 1/2"	16 1/8"	12"	11 3/4"	6 1/8"	5"	12144	1875	131
Orlando1A	12 1/2"	16 1/8"	12"	11 3/4"	6"	4 5/8"	12145	1842	129
Orlando2	12 1/2"	20"	12"	11 3/4"	9 15/16"	8 13/16"	12148	2150	168

Profiles - The DNA of Stone

Type Description
Profile



View Modifiers

Surname
Otago

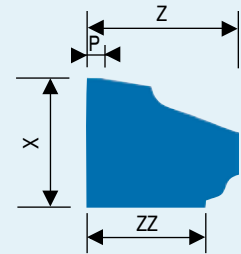

	X	Z	Y	XX	ZZ	P	Unit ID	Cost Factor/Lf	Weight/Lf
Otago1	3 ⁷ / ₈ "	4 ⁵ / ₈ "	12"	-	3 ⁵ / ₈ "	1 ¹ / ₂ "	827	355	14
Otago3	4 ³ / ₄ "	4 ⁵ / ₈ "	12"	-	3 ⁵ / ₈ "	1 ¹ / ₂ "	829	391	16
Otago2	4 ⁷ / ₈ "	4 ⁵ / ₈ "	12"	-	3 ⁵ / ₈ "	1 ¹ / ₂ "	828	395	17
Otago5	5 ¹ / ₄ "	4 ⁵ / ₈ "	12"	-	3 ⁵ / ₈ "	1 ¹ / ₂ "	837	400	19
Otago4	5 ³ / ₈ "	4 ⁵ / ₈ "	12"	-	3 ⁵ / ₈ "	1 ¹ / ₂ "	836	403	19
Otago9	5 ⁵ / ₈ "	4 ⁵ / ₈ "	12"	-	3 ⁵ / ₈ "	1 ¹ / ₂ "	841	407	20
Otago7	6"	4 ⁵ / ₈ "	12"	-	3 ⁵ / ₈ "	1 ¹ / ₂ "	839	427	21
Otago6	6 ¹ / ₈ "	4 ⁵ / ₈ "	12"	-	3 ⁵ / ₈ "	1 ¹ / ₂ "	838	432	22
Otago8	6 ¹ / ₄ "	4 ⁵ / ₈ "	12"	-	3 ⁵ / ₈ "	1 ¹ / ₂ "	840	436	23

Type Description
Profile



View Modifiers

Surname
Owen

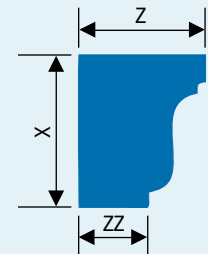

	X	Z	Y	XX	ZZ	P	Unit ID	Cost Factor/Lf	Weight/Lf
Owen2	6"	8"	12"	-	4 ¹ / ₂ "	-	12185	576	36
Owen1	7 ⁵ / ₈ "	6 ⁵ / ₈ "	12"	-	3 ⁵ / ₈ "	-	12184	614	38
Owen3	7 ⁵ / ₈ "	9"	12"	6 ⁷ / ₈ "	6"	6"	12186	828	54
Owen4	9"	5 ³ / ₄ "	12"	-	1 ³ / ₄ "	-	16425	540	39
Owen4A	9"	7 ³ / ₄ "	12"	-	3 ³ / ₄ "	-	16359	756	55

Type Description
Profile

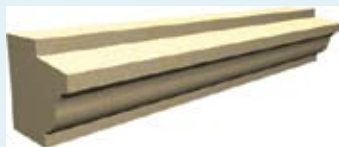

View Modifiers

Surname
Oxford

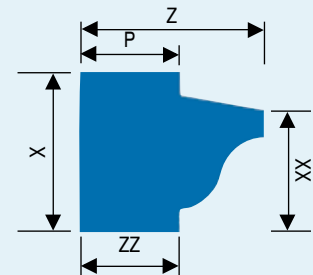

	X	Z	Y	XX	ZZ	P	Unit ID	Cost Factor/Lf	Weight/Lf
Oxford1	6 ¹ / ₂ "	7 ¹ / ₂ "	12"	5 ¹ / ₂ "	4"	4"	14797	546	39
Oxford2	10"	8 ¹ / ₂ "	12"	9"	4"	4"	15279	840	63

Profiles - The DNA of Stone

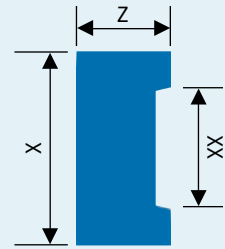

Type Description
Profile

Primary view

View Modifiers

Surname
Recess

	X	Z	Y	XX	ZZ	P	Unit ID	Cost Factor/Lf	Weight/Lf
Recess11	5 1/2"	6"	12"	4"	-	-	12320	421	31
Recess4	6"	6"	12"	3"	-	-	12323	432	32
Recess5	6 1/4"	4"	12"	3 1/4"	-	-	12324	368	22
Recess6	8"	4"	12"	3 3/4"	-	-	12326	384	28
Recess9	8"	6"	12"	6"	-	-	12330	480	36
Recess12	8"	6 1/2"	12"	4 1/2"	-	-	16042	612	43
Recess3	9 3/8"	5"	12"	7 3/8"	-	-	9161	600	42
Recess10	9 5/8"	4 5/8"	12"	7 5/8"	-	-	12319	587	37
Recess2	9 3/4"	6"	12"	7 3/4"	-	-	9160	750	53
Recess7	10"	6"	12"	8"	-	-	12327	630	46
Recess1	12"	5"	12"	10"	-	-	12318	750	54
Recess8	12 7/8"	3 1/2"	12"	6 7/8"	-	-	12328	660	32

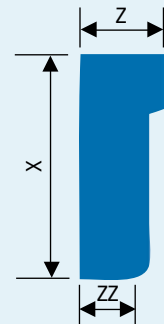

Type Description
Profile

View Modifiers

Surname
Record

	X	Z	Y	XX	ZZ	P	Unit ID	Cost Factor/Lf	Weight/Lf
Record5	5 1/4"	3"	12"	-	2"	-	16361	350	12
Record1	5 1/2"	3"	12"	-	2"	-	16360	350	13
Record4	8"	3"	12"	-	2"	-	14566	353	19
Record4A	8"	5"	12"	-	4"	-	16362	384	27
Record3	8 1/2"	3"	12"	-	2"	-	14581	356	20
Record2	9"	3"	12"	-	2"	-	14738	357	21

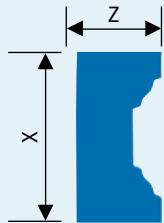
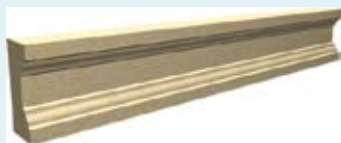

Type Description
Profile

Primary view

View Modifiers

Surname
Renown

	X	Z	Y	XX	ZZ	P	Unit ID	Cost Factor/Lf	Weight/Lf
Renown1	6"	3"	12"	-	-	-	14651	357	16

Profiles - The DNA of Stone

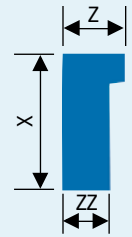

Type Description
Profile

View Modifiers
Surname
Reed

	X	Z	Y	XX	ZZ	P	Unit ID	Cost Factor/Lf	Weight/Lf
Reed5	6 ³ / ₈ "	6 ¹ / ₂ "	12"	-	5 ¹ / ₈ "	-	12358	446	33
Reed8	6 ¹ / ₂ "	4 ⁷ / ₈ "	12"	-	4 ⁵ / ₈ "	-	12362	380	26
Reed4	7 ³ / ₄ "	4"	12"	-	3 ¹ / ₄ "	-	12355	372	26
Reed2	8"	7 ³ / ₄ "	12"	-	6"	-	12353	745	49
Reed6	8"	6 ⁵ / ₈ "	12"	-	5"	-	12359	641	42
Reed7	8"	5"	12"	-	4"	-	12360	480	36
Reed11	9 ⁵ / ₈ "	4"	12"	-	3"	-	12352	464	31
Reed1	10 ¹ / ₄ "	4 ³ / ₈ "	12"	-	3 ⁵ / ₈ "	-	12349	525	36
Reed3	10 ⁵ / ₈ "	5"	12"	-	4"	-	12354	641	43
Reed10	10 ⁹ / ₈ "	5"	12"	-	4 ¹ / ₂ "	-	12350	638	48
Reed12	12"	8"	12"	-	6"	-	16363	1008	71
Reed9	12 ³ / ₄ "	5"	12"	-	3 ¹ / ₂ "	-	12363	765	49
Reed9A	12 ³ / ₄ "	6"	12"	-	4 ¹ / ₂ "	-	12364	899	63

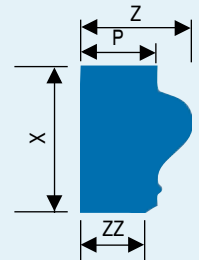

Type Description
Profile

View Modifiers
Surname
Sable

	X	Z	Y	XX	ZZ	P	Unit ID	Cost Factor/Lf	Weight/Lf
Sable1	5 ¹ / ₈ "	4"	12"	-	2 ¹ / ₄ "	2 ¹ / ₄ "	15257	249	13

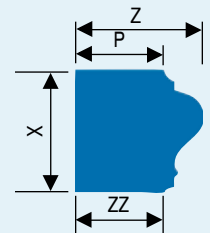

Type Description
Profile

View Modifiers
Surname
Salem

	X	Z	Y	XX	ZZ	P	Unit ID	Cost Factor/Lf	Weight/Lf
Salem6	5 ¹ / ₂ "	3 ⁹ / ₁₆ "	12"	-	1 ⁵ / ₈ "	1 ⁵ / ₈ "	16366	357	13
Salem2	6"	6 ¹ / ₂ "	12"	-	4 ¹ / ₂ "	4 ¹ / ₂ "	12423	468	31
Salem2A	6"	3 ⁵ / ₈ "	12"	-	1 ⁵ / ₈ "	1 ⁵ / ₈ "	12424	400	16
Salem1	7"	6 ¹ / ₂ "	12"	-	4 ¹ / ₂ "	4 ¹ / ₂ "	12421	546	37
Salem3	8"	6 ¹ / ₂ "	12"	-	4"	4"	12426	624	40
Salem7	8"	6 ¹ / ₂ "	12"	-	4 ¹ / ₂ "	4 ¹ / ₂ "	16367	629	42
Salem4	10"	6 ¹ / ₂ "	12"	-	3 ⁵ / ₈ "	3 ⁵ / ₈ "	12427	780	49
Salem5	10"	7 ¹ / ₈ "	12"	-	5"	5"	12428	936	63

301 Pleasant Drive • Dallas, TX 75217
 (800) 398-1199 • FAX (214) 398-1293
 www.stonelegends.com • sales@stonelegends.com

STONE LEGENDS

Profiles - The DNA of Stone

Type Description
Profile

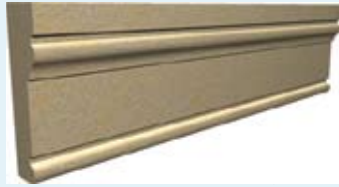

View Modifiers

Surname
Saxon

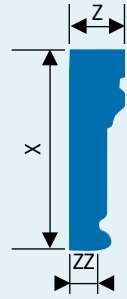

	X	Z	Y	XX	ZZ	P	Unit ID	Cost Factor/Lf	Weight/Lf
Saxon5	6"	3"	12"	-	2 1/8"	-	16368	353	15
Saxon6	6 3/4"	2 15/16"	12"	-	2 3/16"	-	14551	399	16
Saxon2	7"	3"	12"	-	2 1/8"	-	12432	445	17
Saxon4	7"	6"	12"	-	5 1/8"	-	12434	593	36
Saxon1	10"	3"	12"	-	2 1/8"	-	12431	480	25
Saxon3	10"	6"	12"	-	5 1/8"	-	12433	770	52
Saxon7	12"	6"	12"	-	4 5/8"	-	16369	861	63

Type Description
Profile



View Modifiers

Surname
Sienna

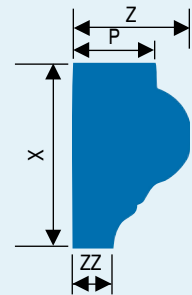

	X	Z	Y	XX	ZZ	P	Unit ID	Cost Factor/Lf	Weight/Lf
Sienna1	7 1/2"	4 15/16"	12"	-	1 5/8"	3 1/2"	15355	436	26
Sienna2	8 1/2"	7 5/16"	12"	-	2 1/4"	6 1/4"	15360	714	51

Type Description
Profile



View Modifiers

Surname
Staccato

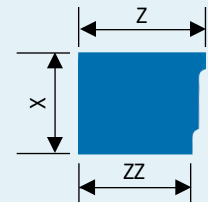

	X	Z	Y	XX	ZZ	P	Unit ID	Cost Factor/Lf	Weight/Lf
Staccato2	4 1/2"	4 1/4"	12"	-	3 1/2"	-	16429	351	15
Staccato3	4 1/2"	2 3/4"	12"	-	2"	-	16430	350	11
Staccato4	4 1/2"	7 1/2"	12"	-	6 3/4"	-	16291	405	29
Staccato1	6"	7 1/2"	12"	-	6 3/4"	-	16428	504	35
Staccato5	8 1/2"	3 1/4"	12"	-	2 1/4"	-	16431	356	23

Profiles - The DNA of Stone

Type Description
Profile



View Modifiers

Surname

Stepney

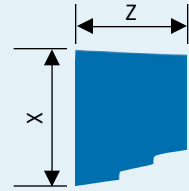

	X	Z	Y	XX	ZZ	P	Unit ID	Cost Factor/Lf	Weight/Lf
Stepney1	8"	6 1/2"	12"	-	-	-	16289	576	41
Stepney2	11 1/2"	9 1/2"	12"	-	-	-	16290	1188	86

Type Description
Profile



View Modifiers

Surname

ThreeStep

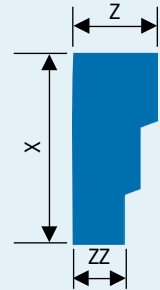

	X	Z	Y	XX	ZZ	P	Unit ID	Cost Factor/Lf	Weight/Lf
ThreeStep5	6 1/2"	4"	12"	-	2 1/2"	-	12599	390	23
ThreeStep5A	6 1/2"	4 1/2"	12"	-	3"	-	12600	410	25
ThreeStep4	7 1/2"	4"	12"	-	2 1/2"	-	12598	440	27
ThreeStep1	12"	4"	12"	-	2 1/2"	-	9169	576	43
ThreeStep3	8"	5 1/6"	12"	-	3 1/6"	-	12597	493	37
ThreeStep2	8 3/4"	4"	12"	-	2 1/2"	-	12596	460	31
ThreeStep6	9"	6"	12"	-	3 3/4"	-	12601	648	49

Type Description
Profile



Primary View

View Modifiers

Surname

Tamara

Tamara1Frieze Front

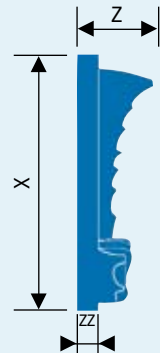

	X	Z	Y	XX	ZZ	P	Unit ID	Cost Factor/ea	Weight/ea
Tamara1Frieze	28"	8 1/4"	20 3/4"	-	2 1/4"	-	15362	6300	280

Tamara1Frieze is available only in 20 3/4" panels.

Profiles - The DNA of Stone

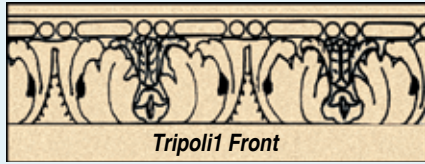

Tripoli1 Front

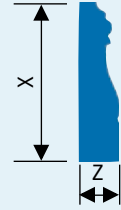

Type Description
Profile

Primary View

View Modifiers

Surname
Tripoli

	X	Z	Y	XX	ZZ	P	Unit ID	Cost Factor/Pc	Weight/Pc
Tripoli1	10"	2 ⁵ / ₁₆ "	24"	-	-	-	12614	1250	22

Tripoli1 is available only in 24" lengths.



Tropics1 Single Panel



Type Description
Profile

Primary View

View Modifiers

Surname
Tropics

	X	Z	Y	XX	ZZ	P	Unit ID	Cost Factor/Pc	Weight/Pc
Tropics1	24"	3"	20 ³ / ₄ "	-	-	-	15984	4550	119

Tropics1 is available only in single and double panel repeating pattern, and with terminator panels for a left or a right end.

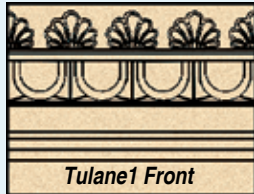

Tulane1 Front

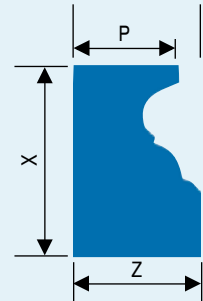

Type Description
Profile

Primary View

View Modifiers

Surname
Tulane

	X	Z	Y	XX	ZZ	P	Unit ID	Cost Factor/Lf	Weight/Lf
Tulane1	9 ¹ / ₂ "	6 ⁷ / ₁₆ "	12"	-	-	5 ¹ / ₄ "	12617	1747	41

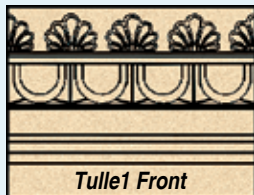

Tulle1 Front

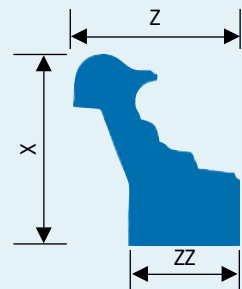

Type Description
Profile

Primary View

View Modifiers

Surname
Tulle

	X	Z	Y	XX	ZZ	P	Unit ID	Cost Factor/Lf	Weight/Lf
Tulle1	15 ⁵ / ₈ "	13 ¹¹ / ₁₆ "	12"	-	9 ¹ / ₄ "	-	12622	3615	92

Profiles - The DNA of Stone

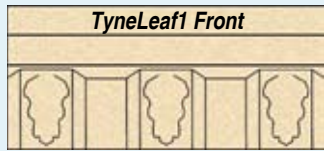

TyneLeaf1 Front

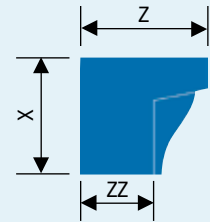

Type Description
Profile

Primary View

View Modifiers

Surname

TyneLeaf

	X	Z	Y	XX	ZZ	P	Unit ID	Cost Factor/Lf	Weight/Lf
TyneLeaf1	3 ⁷ / ₈ "	4 ¹ / ₄ "	12"	-	2 ¹ / ₄ "	-	15309	906	14

TyneLeaf1 is available only in 35⁵/₈" lengths.

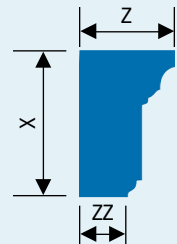
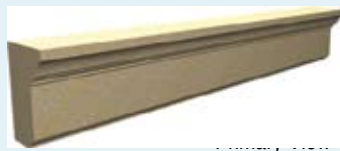

Type Description
Profile

View Modifiers

Surname

Valens

	X	Z	Y	XX	ZZ	P	Unit ID	Cost Factor/Lf	Weight/Lf
Valens1	6"	4"	12"	-	2"	-	15465	358	16

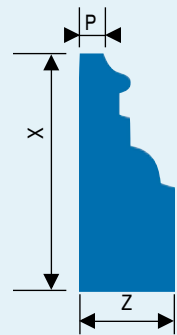

Type Description
Profile

View Modifiers

Surname

Veneto

	X	Z	Y	XX	ZZ	P	Unit ID	Cost Factor/Lf	Weight/Lf
Veneto1	10 ¹ / ₂ "	4 ⁵ / ₁₆ "	12"	-	-	1 ¹ / ₈ "	12671	570	36

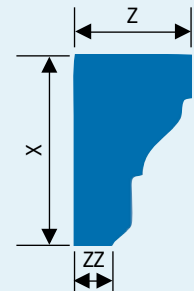
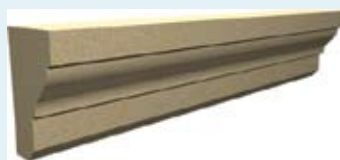

Type Description
Profile

View Modifiers

Surname

Venice

	X	Z	Y	XX	ZZ	P	Unit ID	Cost Factor/Lf	Weight/Lf
Venice1	8"	5"	12"	-	1 ¹ / ₈ "	-	12672	384	27

Profiles - The DNA of Stone



Type Description
Profile

View Modifiers

Surname
Viceroy

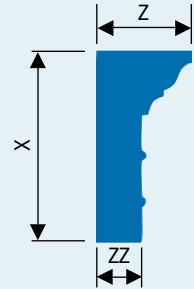

	X	Z	Y	XX	ZZ	P	Unit ID	Cost Factor/Lf	Weight/Lf
Viceroy1	15 ⁵ / ₈ "	7 ⁵ / ₈ "	12"	-	3 ⁵ / ₈ "	-	15072	1080	81

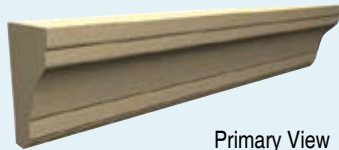

Type Description
Profile

Primary View

View Modifiers

Surname
Vincent

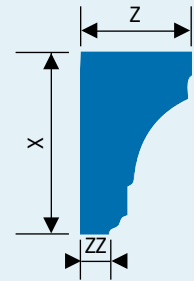

	X	Z	Y	XX	ZZ	P	Unit ID	Cost Factor/Lf	Weight/Lf
Vincent1	7 ³ / ₄ "	4 ⁷ / ₈ "	12"	-	1 ³ / ₈ "	-	12689	453	27
Vincent3	8 ¹ / ₄ "	9 ¹¹ / ₁₆ "	12"	-	6 ³ / ₁₆ "	-	12692	941	63
Vincent4	8 ¹ / ₄ "	9 ¹¹ / ₁₆ "	12"	7 ³ / ₄ "	6 ³ / ₁₆ "	5 ³ / ₄ "	14549	937	59
Vincent5	9"	4 ⁷ / ₈ "	12"	-	1 ³ / ₈ "	-	16371	432	31
Vincent2	10"	6"	12"	-	2 ¹ / ₂ "	-	12690	720	42
Vincent2A	10"	7"	12"	-	3 ¹ / ₂ "	-	12691	762	53
Vincent6	14"	11"	12"	-	4 ¹¹ / ₁₆ "	-	16372	1512	106



Type Description
Profile

View Modifiers

Surname
Vivienne

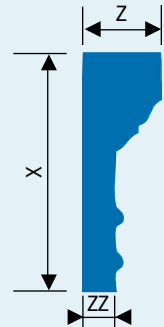

	X	Z	Y	XX	ZZ	P	Unit ID	Cost Factor/Lf	Weight/Lf
Vivienne1	16 ⁷ / ₁₆ "	5 ¹ / ₂ "	12"	-	2 ⁷ / ₁₆ "	-	14726	943	62

Profiles - The DNA of Stone

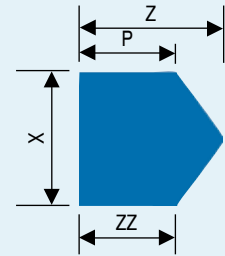
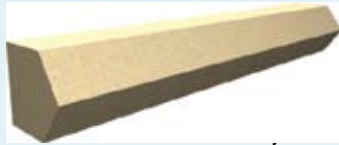

Type Description
Profile

View Modifiers

Surname
Waite

	X	Z	Y	XX	ZZ	P	Unit ID	Cost Factor/Lf	Weight/Lf
Waite2	5"	6"	12"	-	4"	4"	12699	359	21
Waite1	5 ⁵ / ₈ "	6"	12"	-	4"	4"	12698	388	25

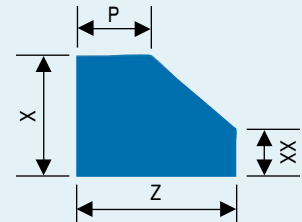

Type Description
Profile

View Modifiers

Surname
Wedge

	X	Z	Y	XX	ZZ	P	Unit ID	Cost Factor/Lf	Weight/Lf
Wedge5	2 ³ / ₈ "	6"	12"	1 ¹ / ₂ "	-	3/4"	12781	357	13
Wedge3	2 ¹ / ₂ "	4 ¹ / ₂ "	12"	2 ¹ / ₂ "	-	1"	12777	350	10
Wedge7	2 ¹ / ₂ "	6"	12"	2 ¹ / ₂ "	-	1 ³ / ₄ "	12783	405	15
Wedge26	2 ³ / ₄ "	4 ¹ / ₂ "	12"	2 ¹ / ₂ "	-	3/4"	12773	351	11
Wedge13	3"	7"	12"	2"	-	4"	12759	361	17
Wedge17	4"	5"	12"	3"	-	1 ¹ / ₂ "	12763	383	17
Wedge20	4 ¹ / ₂ "	5"	12"	1"	-	1 ¹ / ₂ "	12767	373	14
Wedge16	4 ⁷ / ₈ "	7 ³ / ₄ "	12"	3"	-	1 ¹ / ₂ "	12762	353	25
Wedge2	5"	5"	12"	4"	-	1"	12766	386	22
Wedge4	5"	4 ¹ / ₂ "	12"	4 ¹ / ₂ "	-	1"	12780	373	20
Wedge6	5"	8"	12"	4"	-	1"	12782	480	36
Wedge11	5"	6"	12"	4 ¹ / ₄ "	-	2"	12756	410	27
Wedge18	5"	6 ¹ / ₂ "	12"	4"	-	2 ¹ / ₂ "	12764	406	26
Wedge22	5"	5 ¹ / ₂ "	12"	4 ¹ / ₂ "	-	2"	12769	391	18
Wedge23	5"	6"	12"	2 ¹ / ₂ "	-	1"	12770	402	19
Wedge24	5"	9"	12"	4 ³ / ₄ "	-	5 ¹ / ₂ "	12771	518	37
Wedge25	5"	9"	12"	4 ¹ / ₂ "	-	1"	12772	513	35
Wedge1	5 ¹ / ₂ "	7 ¹ / ₂ "	12"	2 ¹ / ₂ "	-	3 ¹ / ₂ "	12753	495	37
Wedge21	5 ¹ / ₂ "	5 ¹ / ₂ "	12"	4 ¹ / ₂ "	-	3/4"	12768	396	24
Wedge19	5 ³ / ₁₆ "	10"	12"	5 ⁵ / ₁₆ "	-	6"	12765	1104	81
Wedge9	6"	3"	12"	3 ¹ / ₂ "	-	3/4"	12785	353	16
Wedge12	6"	6 ⁵ / ₈ "	12"	5 ¹ / ₄ "	-	5/8"	12757	382	31
Wedge31	6"	7"	12"	4 ¹ / ₂ "	-	3"	14009	504	31
Wedge28	6 ³ / ₁₆ "	8 ⁵ / ₈ "	12"	2"	-	3/4"	12775	612	41
Wedge14	7 ¹ / ₂ "	4"	12"	5 ⁷ / ₈ "	-	2 ⁵ / ₈ "	12760	366	24
Wedge15	8"	6 ⁵ / ₈ "	12"	7"	-	5/8"	12761	557	39
Wedge10	8"	8"	12"	2 ³ / ₈ "	-	6"	12755	768	41
Wedge8	10 ¹ / ₈ "	6 ¹ / ₂ "	12"	5 ⁵ / ₈ "	-	4 ¹ / ₂ "	12784	780	43
Wedge29	10 ⁵ / ₈ "	11"	12"	9 ⁵ / ₈ "	-	6 ¹ / ₂ "	12776	1152	87
Wedge30	10 ⁵ / ₈ "	12 ¹ / ₄ "	12"	4 ¹ / ₄ "	-	7"	12778	1210	84
Wedge27	10 ⁷ / ₈ "	6 ¹ / ₂ "	12"	5 ⁵ / ₈ "	-	4 ¹ / ₂ "	12774	849	53

Profiles - The DNA of Stone

Type Description
Profile



View Modifiers

Surname
Wedgewood

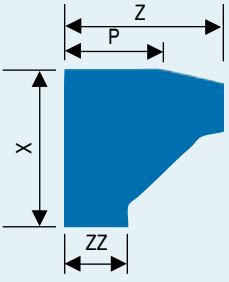

	X	Z	Y	XX	ZZ	P	Unit ID	Cost Factor/Lf	Weight/Lf
Wedgewood1	6 1/2"	6 3/4"	12"	6"	2 3/4"	4 1/4"	12789	359	21

Type Description
Profile



View Modifiers

Surname
Wheat

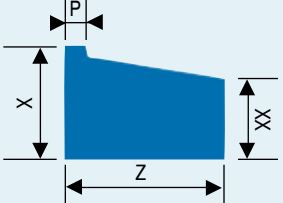

	X	Z	Y	XX	ZZ	P	Unit ID	Cost Factor/Lf	Weight/Lf
Wheat1	5 1/4"	7 1/2"	12"	3 3/4"	-	1"	16138	352	21

Type Description
Profile

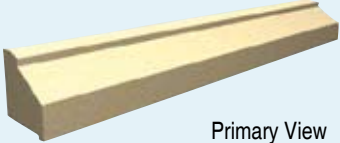

Primary View

View Modifiers

Surname
Wolde

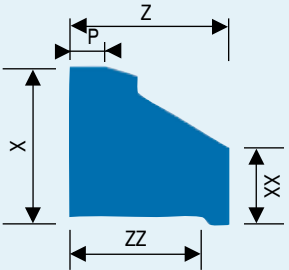

	X	Z	Y	XX	ZZ	P	Unit ID	Cost Factor/Lf	Weight/Lf
Wolde1	4 7/16"	4 1/2"	12"	4 3/16"	3 7/8"	1"	12807	470	17

STONE LEGENDS

301 Pleasant Drive • Dallas, TX 75217
 (800) 398-1199 • FAX (214) 398-1293
 www.stonelegends.com • sales@stonelegends.com